

NEW

UniFlow Laboratory Fume Hoods[®]

When Safety and Performance are of the Essence



UniFlow SE Hoods



UniFlow LE Hoods



UniFlow FM Hoods

NEW UniFlow SL AireStream Fume Hoods
5 Year Warranty, Sustainability, NO Rust

- Fume Hood Service Components**
- Laboratory Ventilation**
- EnviroMax Vented Enclosures**
- UniMax Large Floor Mount Hoods**
- Laboratory Safety Equipment**



HEMC



BETATEK

Address
**654 Petrolia Road,
Toronto, ON M3J 2W3**

Tel: (416) 736-6166
Toll Free: (800) 387 3570
Fax: (416) 736-9346
E-mail: info@betatekinc.com





Welcome to HEMCO

Made in the  U.S.A.

HEMCO is the leading manufacturer of innovative laboratory equipment serving the Sciences and R&D Technology Industries since 1958. Located in Independence, Missouri, the heart of America, and the crossroads of North America a major center for transportation, communication, distribution, and manufacturing industries worldwide.

HEMCO's modern manufacturing and distribution facilities combined with our many years of experience uniquely qualifies us to provide laboratory planning projects. Our extensive engineering, design and manufacturing expertise can transform your laboratory ideas into reality.



Ronald E. Hill P.E.
CEO & Co-Founder

HEMCO celebrates 68th anniversary in 2026.

"This is quite an accomplishment for a small start up business. We were honored by the Mayor of Independence." 2008 was our 50th year, and as we progress into the next 50 years, we look forward to continued growth and service to the industries we serve.

One of our most important associations over the past 30 years is our membership in SEFA (Scientific Equipment & Furniture Association) which this year marks SEFA's 31st anniversary. HEMCO is proud to be one of the founding members since 1988. SEFA is a growing and preferred association that represents all Laboratory Fume Hood Furniture Manufacturers worldwide.

HEMCO's Membership in Technical Associations, Inspires Innovation

The year 2009 marked a new beginning for HEMCO, we became an ISO 9001:2008 certified company. In 2018 HEMCO became an ISO 9001:2015 certified company. The International Standard Organization is recognized in the USA and 178 countries worldwide. HEMCO's management team has adopted the ISO quality management and procedures into our daily operating system. By continuing to improve manufacturing procedures & operations, it creates efficiency with employee involvement. "We say what we do and we do what we say" We strive to make our customers experience number 1, with our prompt service. Completing projects on time and within budget.

The next year, 2010, HEMCO's UniFlow SE Aire Stream, UniFlow LE & UniFlow CE fume hoods became U.L. classified to U.L. 1805 standards for laboratory fume hoods & cabinets. Underwriter Laboratories have 69 labs and certified testing facilities in the US, and over 100 countries worldwide, with 6,600 employees to service the U.L. clients. U.L. has tested HEMCO HiPel composite fiberglass laminate for chemical & flame resistance and to NFPA 45 for plastics suitable to use in the laboratory. HEMCO's fume hoods are tested to meet U.L. standard 3101 for electrical circuitry & are listed and compliant to U.L. 1805 -3101, CSA, and CE classifications.

Consider UniFlow Fume Hoods on your next lab project.

Thank You and as Always Welcome to HEMCO



HEMCO's 50th Anniversary



National Society of Professional Engineers & MSPE Lifetime Member



Scientific Equipment & Furniture Association Lifetime Member



American Chemical Society Chemical Health & Safety Member Since 1989



International Society of Pharmaceutical Engineers Member Since 1994



American Society of Heating, Refrigeration & Air Conditioning Engineers Lifetime Member



International Institute for Sustainable Laboratories Member Since 2002



UL Underwriters Laboratories Certified 1805 and 3101 Since 2010



American Institute of Architects Member Since 2013



Association of Energy Engineers Member Since 2012



National Fire Protection Association Member Since 2012

We invite you to explore our laboratory product lines

UNIFLOW LABORATORY FUME HOODS Page

UniFlow Fume Hoods.....	1
Traditional vs UniFlow Fume Hoods.....	2
UniFlow SL, SE, LE Fume Hoods.....	3
UniFlow CE, SE Walk-in, LE Walk-In Hoods.....	4
UniFlow SE Dual, LE Dual, Auxiliary Air.....	5
UniFlow Perchloric Acid, HDPE, PolyPro.....	6
UniFlow Radioisotope, MLX.....	7
Plan-A-Hood Worksheet.....	8

FUME HOOD SERVICE COMPONENTS Page

Work Surfaces, Base Cabinets, Acid Cabinets.....	9
Wall Mounted Plumbing Fixtures.....	10
Fume Hood Electrical Services.....	11
Sinks and Neutralization Tanks.....	12
Apparatus Grids & Fire Extinguishers.....	13
Chemical Resistance Chart.....	14

FUME HOOD VENTILATION Page

Lab Ventilation Recommendations.....	15
Energy Saving Recommendations.....	16
Fume Hood Ventilation & Duct Design.....	17
Fume Hood Ducting.....	18
Fume Hood Blowers Ordering Info.....	19
Fume Hood Blowers.....	20

LABORATORY FURNITURE Page

Laboratory Furniture Groupings.....	21-26
-------------------------------------	-------

ENVIROMAX ENCLOSURES Page

EnviroMax Vented Enclosures.....	27-28
----------------------------------	-------

UNIMAX FUME HOODS Page

UniMax Fume Hoods.....	29-30
------------------------	-------

LABORATORY SAFETY EQUIPMENT Page

Canopy Hoods FRP and Stainless steel.....	31
Emergency Shower Eye/Face wash Decontamination Booth.....	32



UniFlow[®] AirStream Laboratory Fume Hoods



NEW UniFlow SL AirStream Fume Hoods

UniFlow fume hoods are designed for performance, user protection, & save 50% on reduced energy cost. With exclusive Vector airflow slots to maintain airflow through the fume chamber.

✓ HEMCO offers a complete line of UniFlow laboratory fume hoods. Bench-mounted hoods in widths from 24" to 96". Floor-mounted (walk-in) hoods from 48" to 144" wide and up to 96" deep. UniFlow fume hoods are designed for performance, user protection, & save 50% on reduced energy cost.



U.L., Underwriters Laboratory U.L. 1805 for fume hoods & cabinets, this classification covers construction, materials, flammability, & containment. U.L. 3101 electrical performance is tested using HIPOT testing, (high potential high voltage). HEMCO's test facility is compliant to test fume hoods for U.L.1805 Classification.

✓ CSA, Canadian Standards Associations
CAN/CSA - C22.2 compliant for electrical components

✓ CE European Conforming International
Electrical Configuration

✓ OSHA, Occupational Health & Safety Federal Register
29 CFR part 1910. Part 1910 recommends equipping hoods with an air flow monitor.

✓ SEFA, Scientific Equipment Furniture Association,
SEFA 1-2010 recommended practices for fume hoods

✓ ASHRAE, American Society of Heating, Refrigerating
and Air-Conditioning Engineers, ASHRAE - 110, 1995

✓ ANSI, American National Standards Institute,
Z9.5, 2012 Laboratory Ventilation

✓ ASTM, American Society for Testing and
Materials ASTM E-84, 2001

✓ NFPA, National Fire Protection Association, NFPA - 45, 2000

✓ UniFlow Fume Hoods are listed on

✓ 5 year warranty on all UniFlow SE, **ARCAT** AirStream models which are U.L. 1805 classified, guaranteed

Advantages of UniFlow CAV Bypass Fume Hoods

Cut Energy Costs up to 50%, by reducing the size of the blower & ductwork required, while lowering installation costs.

- 1. Important: by incorporating Sash Management 1-2-3, you are saving 50% on overall energy costs, and providing the best possible user protection & safety.** (see page 7)
- Recommended that hoods be used with sash 1/2 open with face velocity of 80-100 FPM. Sash stop located at 1/2 open position. With upper sash raised to the 1/2 open position the supply air CFM & static pressure are as noted.
- Sash in full open position should be for setup of apparatus & maintenance service only. If design opening is at 1/2 open at 100 FPM, face velocity at full open would be approximately 50 FPM. The recommended face velocity for efficiency & safety is 80-100 FPM. Lower face velocity may compromise user safety.
- When hood is not in use, keep sash in closed position.

- Sash stops are standard on U.L. Classified Fume Hoods. UniFlow SE, LE and CE AirStream fume hoods
- The Sash Stop is designed for user protection and CFM reduction. Allows sash to open to a maximum of half open, providing up to 50% energy savings.
- Sash at full open is primarily designed for set-up of equipment and maintenance. Fume hood users should wear personal safety protection equipment, consult Lab Safety Officer.
- HEMCO recommends 10-12 room air changes per hour for the health & safety of personnel. Example 10' X 20' room 10' high receiving 10 room air changes per hour requires 350 CFM air flow through the lab.
- At an average utility rate of \$7.00 per CFM, a typical annual savings on a 4' fume hood would be \$2705.00 and on a 6' fume hood \$4067.00, by using Sash Management 1-2-3., Sash Stop at 50% open.

Standard Color is Lab White, other colors are available.

Lab White - 01	Silver Beige - 02	Pewter Gray - 03	Zircon Blue - 04

Traditional Fume Hoods vs UniFlow Fume Hoods

Innovation is the Difference Between the Same Perspective and an Entirely New one.



The 1925 Ford Tri-motor, featured all metal construction, no wood. Its fuselage and wings were constructed of corrugated sheet metal, for strength. These aircraft were well-designed, and reliable (for the era).

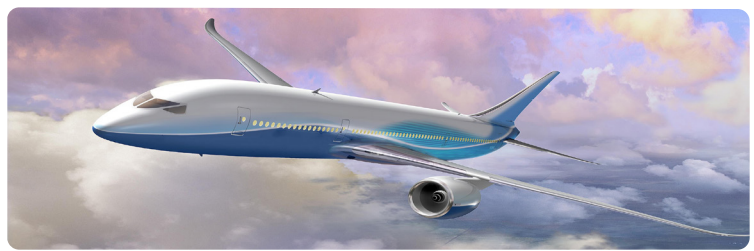

The Boeing 787 Dreamliner features aerodynamic composite construction. Composites have a higher strength to weight ratio, which helps to make the 787 a lighter more energy efficient aircraft.

Traditional Fume Hoods



Wt 435 lbs

1. Fully Assembled Fume Hoods

Traditional Fume Hood 60" wide Constructed of formed painted sheet metal panels & held together with sheet metal fasteners & brackets. Chemical resistant interior liner panels with sharp corners sealed with caulking. 1 year warranty. Heavy, challenging installation.
Weight 435 lbs

UniFlow SE Fume Hood 60" wide Unitized composite superstructure for total chemical resistance. non-metallic construction (**NORUST**). Interior fume chamber one-piece glass smooth, all covered corners for ease of cleaning, 5 year warranty. Unitized construction reduces weight for ease of installation.
Weight 265 lbs

Weight savings difference = 170 lbs

UniFlow SE Fume Hoods



Wt 265 lbs

2. Disassembled Fume Hoods

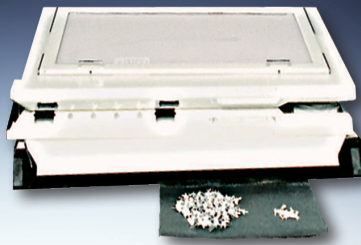

Wt 435 lbs

Traditional Fume Hood 60" wide 170 bolts, nuts and screws removed. 14 painted sheet metal panels with fasteners & brackets removed. 8 flat composite liner panels, no caulk to seal cracks, includes sash assembly & 36" fluorescent 2 bulb T-8 light fixture with steel painted white reflector.
Weight 435 lbs

UniFlow SE Fume Hood 60" wide Unitized construction for superior durability and long life (**NORUST**). Meets NFPA 45 for fire resistance in laboratories. Includes sash assembly & Vapor proof LED light fixture with polished Stainless steel reflector.

Weight 265 lbs

Weight savings difference = 170 lbs



Wt 265 lbs

3. Fume Chamber Composite Panels



Flat Panels

Wt 139 lbs

Traditional Fume Hood 60" wide 8 composite liner panels to fabricate fume chamber. No caulking or sealant in corner cracks. The ceiling panel shown with sheet metal vent outlet. Sash assembly and light assembly removed.
Weight 139 lbs

UniFlow SE Fume Hood 60" wide Unitized composite superstructure for total chemical resistance. non-metallic construction (**NORUST**). Interior fume chamber one-piece glass smooth, all covered corners no joints, 5 year warranty. Unitized construction reduces weight for ease of installation. Sash assembly and light assembly removed.
Weight 210 lbs



Wt 210 lbs Unitized Superstructure

Customer Comments:

Based on the nature of the products we analyze (sulfur chlorides, sulfuric acids, oleums), fume hoods last about two to three years. At the end of three years the chemicals have corroded both the exterior steel panels and the internal steel frame work of the metal hoods. We replaced them eight years ago with HEMCO UniFlow fiberglass fume hoods. The installation was easier, and we have had no repairs since then. We are building a new facility, and we plan to install HEMCO hoods.

Steve Mixon, Chief Chemist

NEW UniFlow SL Fume Hoods 54 inches high

The "NEW" SL series of fume hoods features new dimensions of 54" high OD and 48" high ID. This high performance fume hood features our signature All composite construction for total chemical and fire resistance. With VaraFlow Vector baffle system. Visit: <http://www.hemcocorp.com/sl.html>



NEW UNIFLOW SL AIRESTREAM DESCRIPTIONS	Fume Hood Width "A"			
	48" Cat. No.	60" Cat. No.	72" Cat. No.	96" Cat. No.
1.UniFlow SL AireStream Fume Hood: Air By-pass low flow, constant air volume hood. Dual wall unitized construction, all non-metallic corrosion and fire resistant composite fiberglass construction. In widths of 48", 60", 72" and 96", Depth of 30", and height 54". Vapor proof LED light fixture and control switch are wired to a single point junction box, 115/60Hz. All electrical components are U.L. listed. Fume hood is U.L.1805 classified.	55421	55521	55621	55821
2.UniFlow SL AireStream VAV Fume Hood: Same as #1 above except equipped with variable air volume VAV restricted by-pass feature in place of CAV by-pass feature.	55422	55522	55622	55822
3.UniFlow SL AireStream Fume Hood with Explosion-Proof Light: Same as #1 above except, equipped with explosion proof vapor proof light fixture.	55423	55523	55623	55823
4.UniFlow SL AireStream Fume Hood: Same as #1 above except equipped to comply to international electrical configuration.	55424	55524	55624	55824

UniFlow SE AireStream Fume Hoods 59 inches high

This full duty high efficiency fume hood is designed for maximum energy savings and user protection. Available in CAV and VAV models in 30" or 36" depths. With VaraFlow Vector baffle system. Visit: <http://www.hemcocorp.com/sefh.html>



UNIFLOW SE AIRESTREAM DESCRIPTIONS	Hood Depth "B"	Fume Hood Width "A"			
		48" Cat. No.	60" Cat. No.	72" Cat. No.	96" Cat. No.
1.UniFlow SE AireStream CAV Fume Hood: Air Bypass low flow, constant air volume hood. Dual wall unitized construction, all non-metallic corrosion and fire resistant composite fiberglass construction. In widths of 48", 60", 72" and 96", Depth of 30" and 36", and height 59". Vapor proof LED light fixture and control switch are wired to a single point junction box, 115/60Hz. see page 11. All electrical components are U.L. listed. Fume hood is U.L.1805 classified.	30"	45421	45521	45621	45821
	36"	45431	45531	45631	45831
2.UniFlow SE AireStream VAV Fume Hood: Same as #1 above except equipped with Variable Air Volume VAV restricted bypass feature in place of CAV bypass feature.	30"	45422	45522	45622	45822
	36"	45432	45532	45632	45832
3.UniFlow SE AireStream Fume Hood with Explosion-Proof Light: Same as #1 above except, equipped with explosion proof vapor tight light fixture.	30"	45423	45523	45623	45823
	36"	45433	45533	45633	45833
4.UniFlow SE AireStream Fume Hood International Configuration: Same as #1 above except equipped to comply to international electrical configuration.	30"	45424	45524	45624	45824
	36"	45434	45534	45634	45834

UniFlow LE AireStream Fume Hoods 48 inches high

The LE Series of fume hoods are equipped with all of the features of the SE and SL series but at a value price. The LE is not as tall but still has a standard height interior working height. With VaraFlow Vector baffle system. Visit: <http://www.hemcocorp.com/lefh.html>



UNIFLOW LE AIRESTREAM DESCRIPTIONS	Fume Hood Width "A"				
	36" Cat. No.	48" Cat. No.	60" Cat. No.	72" Cat. No.	96" Cat. No.
1.UniFlow LE AireStream CAV Fume Hood: Air Bypass low flow, constant air volume hood. Dual wall unitized construction, all non-metallic corrosion and fire resistant composite fiberglass construction. In widths of 36", 48", 60", 72" and 96", Depth of 36", and height 48". Vapor proof LED light fixture and control switch are wired to a single point junction box, 115/60Hz. see page 11. All electrical components are U.L. listed. Fume hood is U.L.1805 classified.	35361	35461	35561	35661	35861
2.UniFlow LE AireStream VAV Fume Hood: Same as #1 above except equipped with Variable Air Volume VAV restricted bypass feature, in place of CAV bypass feature.	35362	35462	35562	35662	35862
3.UniFlow LE AireStream Fume Hood with Explosion-Proof Light: Same as #1 above except, equipped with explosion proof vapor tight light fixture.	35363	35463	35563	35663	35863
4.UniFlow LE AireStream Fume Hood International Configuration: Same as #1 above except equipped to comply with optional CE international electrical configuration.	35364	35464	35564	35664	35864

UniFlow CE AireStream Fume Hoods 45 inches high

When space is limited, the CE series of fume hoods is designed with a 24" depth in models from 30" to 72" wide. These efficient CE Fume hoods provide you with the benefits of a full size fume hood with a space saving size. With VaraFlow Vector baffle system. Visit: <http://www.hemcocorp.com/cefh.html>



UNIFLOW CE AIRESTREAM DESCRIPTIONS	Fume Hood Width "A"			
	30" Cat. No.	36" Cat. No.	48" Cat. No.	72" Cat. No.
1.UniFlow CE AireStream CAV Hood with Vapor Proof Light: The unitized superstructure features a molded seamless fume chamber with all corners covered. In widths of 30",36", 48", 72" , Depth of 24", and height 45". Vapor proof light fixture and control switch wired to single point junction box, 115/60Hz. see page 11. All electrical components U.L. listed. Fume hood is U.L.1805 classified.	13041	13641	14841	17241
2.UniFlow CE AireStream VAV Fume Hood: Same as #1 above except equipped with Variable Air Volume VAV restricted bypass feature, in place of CAV bypass feature.	13045	13645	14845	17245
3.UniFlow CE AireStream Hood with Explosion-Proof Light: Same as #1 above except, equipped with explosion proof vapor tight light fixture.	13043	13643	14843	17243
4.UniFlow CE AireStream Fume Hood International Configuration: Same as #1 above except equipped to comply with optional CE international electrical configuration. 220V/50Hz AC. Electrical services, exhaust blowers available. see page 15.	13046	13646	14846	17246
5.Composite Resin Worksurface: 1.25" thick, color: gray, dished, factory installed	13017	13617	14817	17217
6.Phenolic Worksurface: 1.25" thick, color: black, dished	13028	13628	14828	17228

UniFlow SE Walk-In Fume Hoods 94 inches high

UniFlow SE FM Floor Mounted (Walk-In) Hoods are ideally suited for synthesis and other rack type operations where tall apparatus is used or equipment is rolled into the work area. In widths 48", 60", 72", 96", 120" & 144" & depths of 30", 36", and 48". UniFlow Walk-In Hoods are available in standard or special sizes to meet various applications. Modular construction can be shipped disassembled for on-site assembly. Visit: <http://www.hemcocorp.com/fmfh.html>



UNIFLOW SE FLOOR MOUNT DESCRIPTIONS	Fume Hood Width "A"						
	HOOD Depth "B"	48" Cat. No.	60" Cat. No.	72" Cat. No.	96" Cat. No.	120" Cat. No.	144" Cat. No.
1.UniFlow SE Floor Mounted CAV Bypass Fume Hood with Vapor-Proof Light: Superstructure to be modular composite chemical resistant FRP non-metal construction. In widths of 48",60", 72", 96", 120" and 144", Depth of 30",36",48" and height 94". Vapor proof LED light fixture and control switch are wired to a single point junction box, 115/60Hz. see page 11. All electrical components are U.L. listed.	30"	11040	11050	11060	11080	11100	11120
	36"	11042	11052	11062	11082	11102	11122
	48"	11043	11053	11063	11083	11103	11125
2.UniFlow SE VAV Fume Hood: Same as #1 above except equipped with Variable Air Volume VAV restricted bypass feature in place of CAV bypass feature.	30"	11049	11059	11069	11089	11015	11031
	36"	11046	11056	11066	11086	11016	11032
	48"	11047	11057	11067	11087	11017	11033
3.UniFlow SE Fume Hood with Explosion-Proof Light: Same as # 1 above except equipped with explosion proof vapor tight light fixture.	30"	11041	11051	11061	11081	11101	11121
	36"	11044	11054	11064	11084	11104	11126
	48"	11045	11055	11065	11085	11105	11127
4.UniFlow SE Fume Hood International Configuration: Same as #1 above except equipped to comply to international electrical configuration.	30"	11142	11152	11162	11182	11112	11128
	36"	11143	11153	11163	11183	11123	11129
	48"	11144	11154	11164	11184	11124	11130
5.Horizontal Sliding Doors (4 panels on 2 tracks) - for 96", 120" & 144" hoods only					FMHS-8	FMHS-10	FMHS-12

UniFlow LE Walk-In Fume Hoods 96 inches high

UniFlow LE FM Floor Mounted (Walk-In) Hoods are ideally suited for synthesis, distillation & other rack type operations where tall apparatus is used or equipment is rolled into the work area. In widths 48", 60", 72", 96", 120" & 144" and depths of 30", 36", & 48". UniFlow Walk-In Hoods are available in standard or special sizes to meet various applications. Modular construction can be shipped disassembled for on-site assembly. Visit: <http://www.hemcocorp.com/fmfh.html>



UNIFLOW LE FLOOR MOUNT DESCRIPTIONS	Fume Hood Width "A"						
	HOOD DEPTH "B"	48" Cat. w No.	60" Cat. No.	72" Cat. No.	96" Cat. No.	120" Cat. No.	144" Cat. No.
1.UniFlow LE Floor Mounted CAV Bypass Fume Hood with Vapor Proof Light: Super structure to be modular composite chemical resistant FRP non-metal construction. In widths of 48",60", 72", 96", 120" and 144", Depth of 30",36",48" & height 96". Vapor proof LED light fixture & control switch are wired to a single point junction box, 115/60Hz. see page 11.	30"	12040	12050	12060	12080	12100	12120
	36"	12043	12053	12063	12083	12103	12123
	48"	12044	12054	12064	12084	12104	12124
2.UniFlow LE VAV Fume Hood: Same as #1 above except equipped with Variable Air Volume VAV restricted bypass feature in place of CAV bypass feature.	30"	12145	12155	12165	12185	12105	12125
	36"	12146	12156	12166	12186	12106	12126
	48"	12147	12157	12167	12187	12107	12127
3.UniFlow LE Fume Hood with Explosion-Proof Light: Same as #1 above except equipped with explosion proof vapor tight light fixture.	30"	12142	12152	12162	12182	12102	12112
	36"	12143	12153	12163	12183	12103	12113
	48"	12148	12154	12164	12184	12104	12114
4.UniFlow LE Fume Hood International Configuration: Same as #1 above except to comply to international electrical configuration.	30"	12440	12450	12460	12480	12430	12420
	36"	12243	12253	12263	12283	12233	12223
	48"	12244	12254	12264	12284	12234	12224
5.Distillation Base Table Heavy duty welded steel tube table with chemical resistant epoxy powder coat finish, phenolic worksurface.	29"	54818	56018	57218	59618	510018	512018
	35"	54838	56038	57238	59638	510038	512038
	47"	54848	56048	57248	59648	510048	512048
6.Horizontal Sliding Doors: for 96", 120" and 144" hoods only					FMHS-8	FMHS-10	FMHS-12

UniFlow SE Dual Entry Fume Hoods 59 inches high

UniFlow SE Dual Entry Air Bypass Hoods are ideal for demonstration or applications where observation and access is required from both sides of the fume hood. Dual Entry Hoods are available in 48", 60", 72", & 96" widths and in 30", 36" & 48" depths. They can be positioned on an island or in peninsular locations. Dual Entry Hoods can also be located on a common wall of two rooms with accessibility from either room. Visit: <http://www.hemcocorp.com/dual.html>



UNIFLOW SE DUAL ENTRY DESCRIPTIONS		Hood Depth "B"	FUME HOOD WIDTH "A"			
			48" Cat. No.	60" Cat. No.	72" Cat. No.	96" Cat. No.
1. UniFlow SE Dual Entry Bypass CAV Hood 30" Depth: Superstructure to be modular composite chemical resistant FRP non-metal construction. Interior fume chamber to be glass-smooth with bell shaped exhaust collar. In widths of 48", 60", 72", 96", Depth of 30", 36", 48" and height 59". Vapor proof light fixture and control switch are wired to a single point junction box, 115/60Hz. see page 11. All electrical components are U.L. listed.		30"	12140	12150	12160	12180
		36"	12340	12350	12360	12380
		48"	12240	12250	12260	12280
2. Vertical Sash Option: Add suffix to catalog number.			VS-4	VS-5	VS-6	VS-8
3. 30" Base Cabinet Assembly: Consists of cabinet(s) & 6" finished back panels.	28" deep cabinet access one side.		50430	50530	50630	50830
4. 36" Base Cabinet Assembly: (2) cabinets & 12" finished back panels.	34" deep - cabinet access one side.		50436	50536	50636	50836
5. 48" Base Cabinet Assembly: Consists of (4) cabinets and 2" filler panels.	46" deep - cabinet access both sides		50448	50548	50648	50848

UniFlow LE Dual Entry Fume Hoods 48 inches high

UniFlow LE Dual Entry Air Bypass Hoods are ideal for demonstrations or applications where observation and access is required from both sides of the fume hood. Dual Entry Hoods are available in 48", 60", 72", & 96" widths and in 30", 36" & 48" depths. They can be positioned on an island or in peninsular locations. Hoods can be also located on a common wall of two rooms with accessibility from either room. Visit: <http://www.hemcocorp.com/dual.html>



UNIFLOW LE DUAL ENTRY DESCRIPTIONS		Hood Depth "B"	FUME HOOD WIDTH "A"			
			48" Cat. No.	60" Cat. No.	72" Cat. No.	96" Cat. No.
1. LE Dual Entry Bypass CAV Hood: Superstructure to be modular composite chemical resistant FRP non-metal construction. Interior fume chamber to be glass-smooth with bell shaped exhaust collar. In widths of 48", 60", 72", 96", Depth of 30", 36", 48" and height 48". Vapor proof light fixture and control switch are wired to a single point junction box, 115/60Hz. see page 11. All electrical components are U.L. listed.		30"	35431	35531	35631	35831
		36"	35441	35541	35641	35841
		48"	35451	35551	35651	35851
2. Vertical Sash Option: Add suffix to catalog number. Includes sash stops at 1/2 open position.			VS-4	VS-5	VS-6	VS-8
3. 30" Base Cabinet Assembly: Consists of cabinet(s) & 6" finished back panels.	28" deep - cabinet access from one side only		50430	50530	50630	50830
4. 36" Base Cabinet Assembly: (2) cabinets & 12" finished back panels.	34" deep - cabinet access from one side only		50436	50536	50636	50836
5. 48" Base Cabinet Assembly: Consists of (4) cabinets and 2" filler panels.	46" deep - cabinet access from both sides		50448	50548	50648	50848

UniFlow Auxiliary Air Fume Hoods 59 inches high

The energy saving Auxiliary Air Fume Hood requires zero room air. This is because the auxiliary air supply is equal to the CFM exhaust of the hood - thus zero room air is required. With sash at an 1/2 open operating position and a face velocity of 100 fpm, the supply equals the exhaust; which makes up for insufficient room air availability and by not exhausting expensive existing tempered room air. . Visit: <http://www.hemcocorp.com/aux1.html>

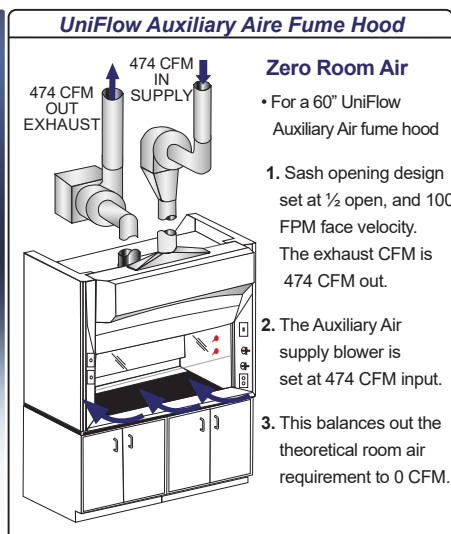

UNIFLOW AUXILIARY AIR DESCRIPTIONS		Hood Depth "B"	FUME HOOD WIDTH "A"		
			48" Cat. No.	60" Cat. No.	72" Cat. No.
1. UniFlow Auxiliary Air CAV Bypass Fume Hood with Vapor-Proof Light: Superstructure to be unitized composite FRP fire resistant non-metallic construction. Integral fume chamber to be seamless glass-smooth with all covered corners with adjustable VaraFlow baffle system and bell shaped exhaust collar. Vapor proof LED light fixture and control switch are wired to a single point junction box, 115/60Hz. see page 11. All electrical components are U.L. listed.		30"	21421	21521	21621
2. UniFlow Auxiliary Air By Pass Fume Hood with Explosion-Proof Light: Same as #1 above except equipped with explosion-proof vapor-proof light fixture Class I, Div II Groups A B C & D, Class II Div II Groups F & G electrical fixture installed but not wired, must be wired to comply with local codes.		30"	21423	21523	21623

UniFlow Perchloric Acid Fume Hoods 59 inches high

UniFlow Perchloric Acid Fume Hoods feature either a type 316 stainless steel or PVC one-piece fume chamber with integral worksurface and are engineered for the safe handling of perchloric acids in laboratory procedures. Perchloric Acid Hoods are offered in sizes 48", 60", & 72" widths and include a dedicated wash down and exhaust system. Note: Perchloric Acid Hoods are for perchloric acid use only. Visit: <http://www.hemcocorp.com/perch.html>



UNIFLOW PERCHLORIC ACID DESCRIPTIONS		Hood Depth "B"	FUME HOOD WIDTH "A"		
			48" Cat. No.	60" Cat. No.	72" Cat. No.
1.Uniflow 316 Stainless Steel Perchloric Acid Laboratory Fume Hood: Seamless type 316 stainless steel fume chamber with integral worksurface and drainage trough with baffle and exhaust collar. Hood has built-in wash down system with spray nozzles and piping to front mounted control valve. In widths of 48",60", 72", Depth of 30",36" and height 60.25". Explosion proof light fixture and control switch are wired to a single point junction box, 115/60Hz. see page 11. All electrical components are U.L. listed.	30"	12401	12501	12601	
	36"	12411	12511	12611	
2.Uniflow PVC Perchloric Acid Laboratory Fume Hood: Seamless PVC fume chamber with integral worksurface and drainage trough, with baffle and exhaust collar. Hood has built-in wash down system with spray nozzles and piping to front mounted control valve. Picture frame sash opening with counterbalanced clear tempered safety glass sash with chemical resistant PVC framing, track, and aerodynamic sash lift. Explosion-proof light fixture Cat. No. 50034, installed but not wired,115/230V, 50/60Hz AC, Class I Div II Groups A B C D, Class II Div II Groups F&G, all electrical components UL listed.	30"	12421	12521	12621	
	36"	12431	12531	12631	

UniFlow HDPE Acid Digestion Hoods 59 inches high

UniFlow HDPE Acid Digestion Fume Hoods feature a one-piece fume chamber with integral reinforced work surface, and baffles constructed of High Density Polyethylene. Digestion hoods come in 48", 60" & 72" widths & feature a dedicated wash down & exhaust system. Visit: <http://www.hemcocorp.com/pvcad.html>



UNIFLOW HDPE ACID DIGESTION DESCRIPTIONS		Hood Depth "B"	FUME HOOD WIDTH "A"		
			48" Cat. No.	60" Cat. No.	72" Cat. No.
1.Uniflow HDPE Acid Digestion Laboratory Fume Hood: Seamless HDPE fume chamber with integral worksurface and drainage trough, all coved corners with baffle and exhaust collar. Hood has built-in wash down system with spray nozzles and piping to front mounted control valve. In widths of 48",60", 72", Depth of 30",36"and height 59". Vapor proof LED light fixture & control switch are wired to a single point junction box, 115/60Hz. see page 11. All electrical components are U.L. listed.	30"	23411	23511	23611	
	36"	23421	23521	23621	
2.Uniflow HDPE Acid Digestion Laboratory Fume Hood: Same as #1 above, except without trough and wash down.	30"	23431	23531	23631	
	36"	23441	23541	23641	
3.Polypro Exhaust Blower: Belt driven, include TEFC motors and feature a spray wash nozzle and drain in the blower housing. The specifications to the right are based on 100 FPM face velocity.	(For 48" hoods) 1/2 HP Blower - 800 CFM @ 1" SP	51495			
	(For 60" hoods) 1/2 HP Blower - 1000 CFM @ 1" SP		51496		
	(For 72" hoods) 3/4 HP Blower - 1200 CFM @ 1" SP			51497	

UniFlow PolyPro Fume Hoods 59 inches high

UniFlow Polypro Trace Metals Fume Hoods are designed for applications where no metal can be present. These hoods feature a totally non-metallic construction and are available in sizes of 48", 60", and 72" widths and 30" or 36" depths. Visit: <http://www.hemcocorp.com/tm.html>



UNIFLOW POLYPRO TRACE METALS DESCRIPTIONS		Hood Depth "B"	FUME HOOD WIDTH "A"		
			48" Cat. No.	60" Cat. No.	72" Cat. No.
1.Uniflow Polypro Trace Metal Laboratory Fume Hood: Welded one-piece polypro fume chamber with integral worksurface, baffle and exhaust collar. Picture frame sash opening with horizontal sliding with chemical resistant PVC framing and track and aerodynamic sash lift. In widths of 48",60", 72", Depth of 30",36",48" and height 60.25".Vapor proof light fixture and control switch are wired to a single point junction box, 115/60Hz. see page 11. All electrical components are U.L. listed.	30"	25041	25051	25061	
	36"	25141	25151	25161	
2.Polypro Trace Metals Exhaust Blower: High efficiency impellers produce low power consumption, reduced operating costs and quiet operation. Non-static & oil resistant V-belt, cast iron pulleys. Chemical resistant for hostile or hazardous environments. 15V single phase or three phase. (see page 15)	(For 48" hoods) 1/2 HP Blower 400 CFM @ 1" SP	51495			
	(For 60" hoods) 1/2 HP Blower 500 CFM @ 1" SP		51496		
	(For 72" hoods) 3/4 HP Blower 600 CFM @ 1" SP			51497	

UniFlow Radioisotope Fume Hoods 59 inches high

UniFlow Radioisotope Fume Hoods are available in 48", 60", & 72" widths. Interior fume chamber is constructed of welded type 304 stainless steel to prevent absorption of radioactive and corrosive materials. Stainless steel baffle is removable for ease of cleaning. Worksurface is welded integral to the fume chamber and reinforced to support heavy isotope shielding materials. Visit: <http://www.hemccorp.com/radio.html>



UNIFLOW RADIOISOTOPE DESCRIPTIONS	Hood Depth "B"	FUME HOOD WIDTH "A"		
		48" Cat. No.	60" Cat. No.	72" Cat. No.
1. UniFlow Radioisotope Fume Hood with Stainless Steel Interior Liner. Seamless type 304 stainless steel fume chamber with integral worksurface all covered corners with baffle and exhaust collar. Picture frame sash opening with counterbalanced clear tempered safety glass sash with chemical resistant stainless steel framing, track, and aerodynamic sash lift. Vapor proof LED light fixture and control switch are wired to a single point junction box, 115/60Hz, 230V 50Hz, VAC All electrical components are U.L. listed. Optional electrical services see page 11.	30"	14401	14501	14601
RADIOISOTOPE EXHAUST BLOWERS & FILTER SYSTEMS				
2. HEPA Filter Bag-In/Bag-Out Filter is contained within a type 304 stainless steel housing with bag-in/bag-out attachment and prefilter. HEPA is 99.99% efficient and the prefilter is 30% efficient. Filter is rated at 1000 CFM. 1 filter required for 48" and 60"hoods; 2 filters required for 72" hoods.		51189	51189	51189
3. Carbon Filter Bag-In/Bag-Out Filter is contained within a type 304 stainless steel housing with bag in, bag out attachment and prefilter.		51198	51198	51198

UniFlow MLX Fume Hoods 59 inches high

The UniFlow MLX series of Fume Hoods are designed and built to accommodate larger equipment and procedures that traditional fume hoods cannot handle. MLX hoods range in size from 60" to 120" wide and 30" to 48" in depth. The MLX series of fume hoods are offered in CAV and VAV models. The modular construction allows the hood to be disassembled. With VaraFlow Vector baffle system. Visit: <http://www.hemccorp.com/mlx.html>



UNIFLOW MLX DESCRIPTIONS	HOOD DEPTH "B"	FUME HOOD WIDTH "A"			
		60" Cat. No.	72" Cat. No.	96" Cat. No.	120" Cat. No.
1. UniFlow MLX AireStream CAV Fume Hood: Air By-pass low flow, constant air volume hood. Dual wall modular construction, all non-metallic corrosion and fire resistant composite fiberglass construction. AireStream VaraFlow baffle system with vector slots and transition bell exhaust connection. In widths of 60", 72", 96", 120", Depth of 30", 36", 48" and height 59". Vapor proof LED light fixture and control switch are wired to a single point junction box, 115/60Hz. see page 11. All electrical components are U.L. listed.	30"	65521	65621	65821	651021
	36"	65531	65631	65831	651031
	48"	65541	65641	65841	651041
2. UniFlow MLX AireStream VAV Fume Hood: Same as #1 above except equipped with variable air volume VAV restricted by-pass feature in place of CAV by-pass feature. Ducting must be connected to optional VAV exhaust system controls.	30"	65522	65622	65822	651022
	36"	65532	65632	65832	651032
	48"	65542	65642	65842	651042
3. UniFlow MLX AireStream Fume Hood with Explosion Proof Light: Same as #1 above except, equipped with explosion proof vapor proof light fixture.	30"	65523	65623	65823	651023
	36"	65533	65633	65833	651033
	48"	65543	65643	65843	651043
4. UniFlow MLX AireStream Fume Hood: Same as #1 above except equipped to comply to international electrical configuration.	30"	65524	65624	65824	651024
	36"	65534	65634	65834	651034
	48"	65544	65644	65844	651044
5. Horizontal Sliding Sash Option: Add suffix to number above		65HS-5	65HS-6	65HS-8	65HS-10

SASH OPTIONS

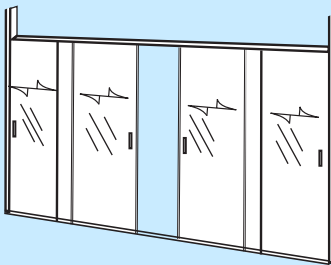

Horizontal Sashes

Max opening is 50%, (4) panels on (2) tracks, conveniently lift out for equipment set-up or cleaning. For 50% reduction of air supply.

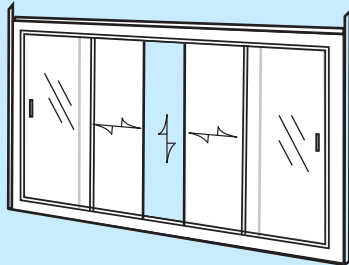

Combination Horizontal / Vertical Sash Offers the advantages of both sash types. Horizontal sash offer energy savings while vertical option allows full access to the fume chamber. Frame is of type 304 stainless steel.

72" CAV Fume Hood vs 72" VAV Fume Hood

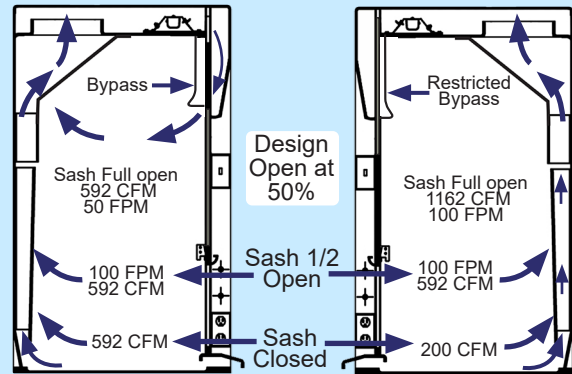

- The CAV with Constant Volume exhaust blower (592 CFM), maintains 100 FPM face velocity at 1/2 open safety position.
- The VAV fume hood would need to be equipped with a variable volume exhaust system to maintain 100 FPM at any sash opening height. At Sash full open the CFM is 1162

HEMCO Plan-A-Hood Worksheet

The Following is a sample of the UniFlow SE AireStream Plan-A-Hood Worksheet, Plan-A-Hood Worksheets are also available for LE and CE AireStream fume hoods. To access go to www.HEMCOcorp.com select the model and click on the Plan-A-Hood link.

UNIFLOW FUME HOOD	QTY	CAT. NO.
AIR BY PASS / CAV		
CONVENTIONAL / VAV		
AUXILIARY AIR		
DISTILLATION		
RADIOISOTOPE		
PERCHLORIC ACID		
ADA		

AIR FLOW MONITOR	QTY	CAT. NO.
DIGITAL		
ANALOG		
OTHER		

SASH	QTY	CAT. NO.
VERTICAL MOVING STD		
HORIZONTAL MOVING		
COMBINATION H&V		

SASH STOP	QTY	CAT. NO.
SPECIFY LOCATION		

PLUMBING SERVICES*	QTY	CAT. NO.
SERVICE SET OF FOUR		

*SPECIFY AIR,GAS,VAC,C/W OR OTHER

ELECTRICAL SERVICES	QTY	CAT. NO.
DUPLEX RECEPT. 125V, 15A		
DUPLEX RECEPT. 125V, 20A		
SIMPLEX RECEPT. 250 V		
DUPLEX GFI 125V, 15A		
DUPLEX GFI 125V, 20A		

ACCESS PANEL	QTY	CAT. NO.
INSIDE LOCATION		
OUTSIDE LOCATION		

CABINETS	QTY	CAT. NO.
SINK CABINET		
BASE CABINET		
ACID CABINET		
FLAMMABLE CABINET		

UniFlow SE AireStream

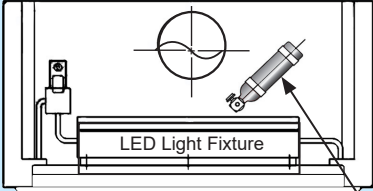

TOP VIEW

Fill out this form and email to:
info@hemcocorp.com

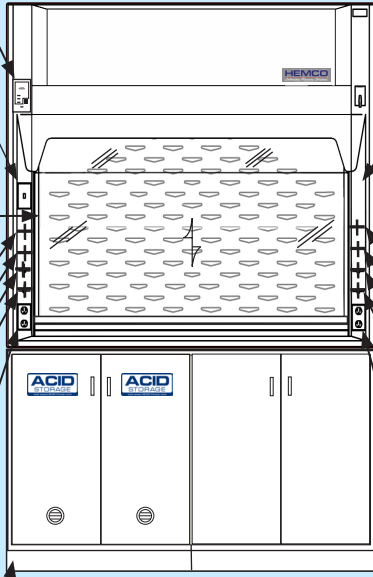

FRONT VIEW WITH BASE CABINET
Optional services shown
(see 9 for service options)



PLAN VIEW OF WORKSURFACE
(see page 9 for worksurfaces)

Questions / Ready to order
Call 1-800-779-4362

CUSTOMER NOTES
<input checked="" type="checkbox"/> LABORATORY FUME HOODS
<input checked="" type="checkbox"/> GASEWORK
<input checked="" type="checkbox"/> WORKSURFACE
<input checked="" type="checkbox"/> LABORATORY FUME HOOD
<input checked="" type="checkbox"/> SPECIFY HEMCO

FIRE EXTINGUISHER	QTY	CAT. NO.
20 SQ FT DRY CHEMICAL		
30 SQ FT DRY CHEMICAL		
50 CU FT HALON		
125 CU FT HALON		

BLOWER SWITCH	QTY	CAT. NO.
TOGGLE SWITCH 125V, 15A		
TOGGLE SWITCH 125V, 20A		
TOGGLE SWITCH. 250V, 20A		
TOGGLE SWITCH W/PILOT		
MOTOR STARTER SWITCH		

PLUMBING SERVICES*	QTY	CAT. NO.
SERVICE SET OF FOUR		

*SPECIFY AIR,GAS,VAC,C/W OR OTHER

ELECTRICAL SERVICES	QTY	CAT. NO.
DUPLEX RECEPT. 125V, 15A		
DUPLEX RECEPT. 125V, 20A		
SIMPLEX RECEPT. 250 V		
DUPLEX GFI 125V, 15A		
DUPLEX GFI 125V, 20A		

ACCESS PANEL	QTY	CAT. NO.
INSIDE LOCATION		
OUTSIDE LOCATION		

WORKSURFACE	QTY	CAT. NO.
EPOXY RESIN		
PHENOLIC RESIN		
304 STAINLESS STEEL		

This is page 1 of 2, to see all Plan-A-Hood work sheets go to www.HEMCOcorp.com select the model & click on Plan-A-Hood

Standard Color is Lab White, other colors are available.

Lab White - 01	Silver Beige - 02	Pewter Gray - 03	Zircon Blue - 04

SE & LE Fume Hood Worksurfaces & Base Cabinets

A complete line of worksurfaces and cabinets to suit any application from economical light duty to heavy acid and solvent use. Select the worksurfaces and cabinets that meet your laboratory's requirements. Standard sizes are listed below. HEMCO's technical staff can make recommendations to suit your needs.

(UniFlow SE, LE hoods only) Epoxy Resin, color: black, 1-1/4" thick, .375" dished

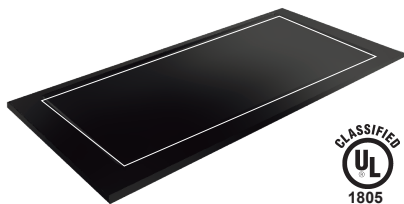

Epoxy Resin Worksurfaces are recommended for general laboratory work where greater chemical resistance is required. Surface is dished 3/8" to contain spillage. Worksurface is cast of thermosetting epoxy resin, creating a molded solid 1-1/4" thick top which is extremely hard, abrasion and heat resistant. Tested to UL 1805 classification.

Size	Cat. No.	Size	Cat. No.
36"W x 30"D	20315	36"W x 36"D	20325
48"W x 30"D	20415	48"W x 36"D	20425
60"W x 30"D	20515	60"W x 36"D	20525
72"W x 30"D	20615	72"W x 36"D	20625
96"W x 30"D	20815	96"W x 36"D	20825

(UniFlow SE, LE) Phenolic Resin, color: black, 1-1/4" thick

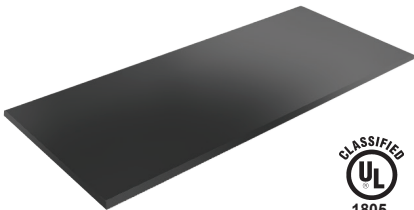

Phenolic Resin Worksurface are recommended for general laboratory work where high concentrations of solvent, acids and alkalis are being worked with. Work surface combines excellent chemical resistance scratch and wear resistance. Surface is flat 1-1/4" thick. Tested to UL 1805 classification.

Size	Cat. No.	Size	Cat. No.
36"W x 30"D	21318	36"W x 36"D	22318
48"W x 30"D	21418	48"W x 36"D	22418
60"W x 30"D	21518	60"W x 36"D	22518
72"W x 30"D	21618	72"W x 36"D	22618
96"W x 30"D	21818	96"W x 36"D	22818

(UniFlow SE, LE hoods only) Stainless Steel, satin finish, 1-1/4" edge, .375" dished

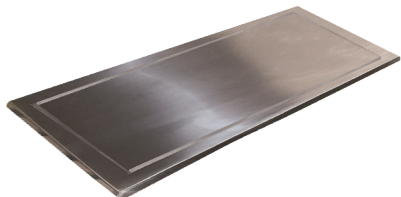

Stainless Steel Fume Hood Worksurfaces are fabricated of type 304, 16 gauge steel with #3 satin finish. Surface is dished 3/8" to contain spillage. All corners, ends, and joints are continuous 1-1/4" heliarc welded and ground smooth. **Type 316 stainless steel is also available.**

Size	Cat. No.	Size	Cat. No.
36"W x 30"D	20316	36"W x 36"D	20326
48"W x 30"D	20416	48"W x 36"D	20426
60"W x 30"D	20516	60"W x 36"D	20526
72"W x 30"D	20616	72"W x 36"D	20626
96"W x 30"D	20816	96"W x 36"D	20826

Fume Hood Base Cabinets & Tables



Casework is tested to be SEFA 8 compliant. Standard cabinets and tables are 35" high and 22" deep. For 36" wide use (1) 36", for 48" wide (1) 48", for 60" wide (2) 30", for 72" wide (2) 36", For 96" wide (2) 48". Standard color is White, Optional Silver Beige, Pewter Gray, or colors to your specifications.

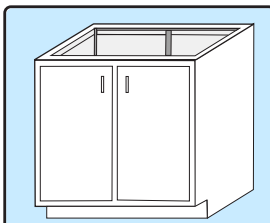

Base Cabinet
Constructed of furniture grade steel. With adjustable shelf and levelers. Standard depth is 22", standard height is 36". Standard color: white

Width	Doors	Cat. No.
30"	2	53011
36"	2	53611
48"	2	54811
60"	2	56011

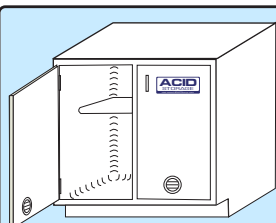

Acid Cabinet Interior is lined with one piece acid resistant white composite resin liner and all coved corners, for superior corrosion resistance, with vents and fixed shelf. Standard depth is 22", standard height is 36".

Width	Doors	Cat. No.
30"	2	15300
36"	2	15360
48"	2	15480
Vent Kit	---	81000

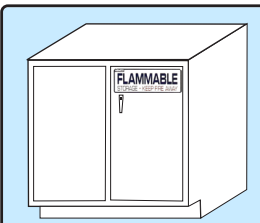

Flammable Cabinet provides safe storage of flammables. Color: silver beige. Constructed of welded double wall furniture grade steel. Cabinet has an adjustable shelf and locking hinged doors. Meets NFPA codes. Standard depth is 22", standard height is 36".

Width	Doors	Cat. No.
30"	2	18300
36"	2	18030
48"	2	18040
Vent Kit	--	81000

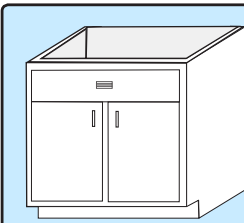

Sink Unit Cabinet
Constructed of furniture grade steel. Cabinet has hinged doors and levelers. Standard depth is 22", standard height is 36".

Width	Doors	Cat. No.
30"	2	71811
36"	2	71812
48"	2	71814
60"	2	71815

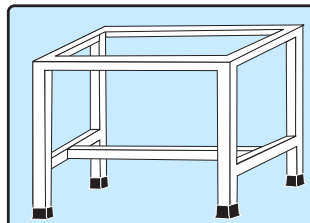

Fume Hood Base Table
Heavy duty, all welded 2" square tube steel construction. Standard depth is 29". Each leg has levelers with fitted black boots. Available in, standard 35" bench height, & 28" sitting height. Standard color: white

Width	Std	Sitting
30"	53012	53032
36"	53612	53632
48"	54812	54832
60"	56012	56032
72"	57212	57232
96"	59612	59632

Fume Hood Wall Mounted Plumbing Fixtures

Fume hood remote control service fixtures feature epoxy coated brass, chemical resistant, color-coded, serrated hose connections, and 3/8" NPT brass valves with rod and handle assembly. Plumbing fixtures are factory installed on hood, they can be pre-plumbed if specified. Please specify service required, fixture location, and inside or outside service access panels. Conforms to ANSI Z21.15.

Service Fixture Color Code Chart	Green - Cold Water	Red - Hot Water	Blue - Gas	Orange - Air
	Yellow - Vacuum	Brown - Nitrogen	Black - Steam	White - Deionized Water



Service Set of Two (specify left or right mounting)
Two remote controlled service fixture set. Color-coded index buttons with matching color-coded serrated tip. Specify service required. Epoxy coated brass.
Cat. No. 50121-FS



Service Set of Four (specify left or right mounting)
Four remote controlled service fixture set. Color-coded index buttons with matching color-coded serrated tip. Specify service required. Epoxy coated brass.
Cat. No. 50141-FS



Service Set of Six (specify left or right mounting)
Six remote controlled service fixture set. Color-coded index buttons with matching color-coded serrated tip. Specify service required. Epoxy coated brass.
Cat. No. 50161-FS



DI Faucet
Pure water 6" rigid PVC goose neck.
Cat. No. 50019



DI Faucet
Pure water 6" swivel tin-lined goose neck. Epoxy coated brass.
Cat. No. 50022



Gooseneck PVC Service Fixture Wall mount, no valve, constructed of PVC.
Cat. No. 51110



Service Fixture
Cold water, remote controlled epoxy coated brass turret.
Cat. No. 50012



Water Faucet with Vacuum Breaker Cold water 6" swivel goose neck. Epoxy coated brass.
Cat. No. 50023



Water Faucet with Vacuum Breaker
Cold water remote controlled 6" swivel goose neck. Turret & goose neck are epoxy coated brass. Cat. No. 50113-CW



Water Faucet
Cold water remote controlled 6" swivel goose neck. Turret and goose neck are epoxy coated brass.
Cat. No. 50112-CW



Service Fixture
Remote controlled single service outlet. color-coded index buttons with matching color coded serrated tip outlets.
Cat. No. 50013



Base Fixture
Deck or wall mount, 3/8 NPT remote, no valve. PVC.
Cat. No. 51013



PVC Lab Turret
Deck or wall mount, 3/8 NPT, no valve. PVC.
Cat. No. 51012



Mix Faucet
Hot and cold remote controlled 6" swivel goose neck. Turret and goose neck are epoxy coated brass.
Cat. No. 50102



Mix Faucet
Hot and cold water remote controlled turret. Turret is of epoxy coated brass.
Cat. No. 50101



High Flow Water Valve, Straight Pattern
Ball valve construction with quarter turn open / close, used for supply and return connections.
Cat No. 51023



Single Keycock
Single flange mounted needle valve, keycock with integral flange and shank connection. Epoxy coated brass. 3/8" NPT with lock nut.
Single Cat. No. 50025
Double Cat. No. 50125



Aspirator
3/8" NPS male inlet
Epoxy coated brass.
Cat. No. 50058



External Mounted Vacuum Breaker
Breaker with 3/8" IPS inlet and outlet. Chrome plated brass. Cat. No. 50044

Fume Hood Electrical Services

Electrical services are UL, CSA & CE listed. They come factory installed, wired to a single point junction box when ordered with fume hoods. Services must be wired to comply with local codes.

Fume Hood Electrical Services (UL)

Duplex Receptacle
115V single phase receptacle. Installed on front column of fume hood. Includes junction box and cover plate. UL listed.

amps	Cat. No.
15 amps	50029-1
20 amps	50029-2

Single Receptacle
230V single phase receptacle. Installed on front column of fume hood. Includes junction box and cover plate. UL listed.

amps	Cat. No.
15 amps	50030-1
20 amps	50030-2

GFI Duplex
115V consists of combination ground fault interrupters, 3-wire polarized grounded. Includes junction box & cover plate. UL listed.

amps	Cat. No.
15 amps	50048-1
20 amps	50048-2

Data Port
Cat 6, 10 gigabit ethernet, (2) port fixture. Installed on front column. Cabling not included.
Cat No. 50053

Light Switch (standard)
115V/15 amps. Includes junction box and cover plate. UL listed.
Cat. No. 50028-1

Blower Switch with Pilot Light
Includes junction box and cover plate. UL listed.

volts/amps	Cat. No.
115V 15 amps	50027-1
230V 20 amps	50027-3

Blower Switch
Mounted in a single gang receptacle box with face plate. Factory mounted not wired. Includes thermal overload protection. Double pole switch for up to 1 HP, single phase, 60 Hz 115V 50 Hz, 230V AC motors. UL listed.
Cat. No. 50050



Service Port Pass-Through
Convenient port allows cords, tubes, or cables to pass to and from the hood.
Cat. No. 50100

Fume Hood Vapor Proof Light Fixtures (UL)

Vapor-Proof Light
Factory installed. Accepts bulb up to 150w, 115V, & LED UL listed, (bulb not included) Standard on CE, Canopy, Universal and EcoFlow hoods.
Cat. No. 50035

Vapor Proof LED Light Fixture

LED fixture with Stainless steel reflector, (2) tube, 115V, UL listed. (LEDs included) LED has a 50,000 hour average life span. Standard on SE and LE Fume hoods.

24 inch..... **Cat. No. 51124**
36 inch..... **Cat. No. 51136**
48 inch..... **Cat. No. 51148**

Fluorescent Lighting

T-5 fixture with Stainless steel reflector, (2) tube, 115V/230V tubes changed from the outside. (fluorescent tubes are included) UL listed. Optional on SE and LE Fume hoods.

24 inch..... **Cat. No. 50224**
36 inch..... **Cat. No. 50236**
48 inch..... **Cat. No. 50248**

Fume Hood Explosion Proof Light Fixtures and Services (UL)

Explosion-Proof Light Std Class I Div II
For use in hazardous locations. Gray, two-coat epoxy finish with easily removed prismatic globe. Factory mounted, not wired. Accepts compact fluorescent or LED, (bulb not included) 115V /230V UL listed. Class I Div II Group A, B,C,D Class II Div II Group F & G **Cat. No. 50034**

Explosion-Proof Fixture Class I Div I
For use in hazardous locations. Gray, two coat epoxy finish with easily removed prismatic globe. Accepts compact fluorescent or LED, (bulb not included) 115V/230V. Factory mounted, not wired. UL listed. Class I Div I Group C, D, Class II Div I Group E, F & G **Cat. No. 50038**

Explosion-Proof Fluorescent Lighting Class I Div I
fixture is (2) tube, 115V/230V with tubes changed from the outside. UL listed. (fluorescent tubes are included)
24 inch..... **Cat. No. 50077**
48 inch..... **Cat. No. 50078**

Explosion-Proof Switch Class I Div I or II
For use in hazardous locations. Surface mount type with cast aluminum housing. Specify 115V/20 amp or 230V/20 amp. UL listed.
Cat. No. 50036

Explosion-Proof Plug Class I Div I or II
Adaptable for use with all receptacles. 3-pole, 2-wire, Specify 115V/20 amp or 230V/20 amp AC. Not installed at factory. UL listed.
Cat. No. 50039

Explosion-Proof Receptacle Class I Div I or II
For use in hazardous locations. Surface mount type with aluminum housing, 3-pole, 2-wire, Specify 115V/20 amp or 230V/20 amp. Not installed at factory. UL listed.
Cat. No. 50037

Explosion-Proof Ground Fault Interrupter
For use in hazardous locations. Factory sealed GFI is designed to interrupt a circuit when a ground fault is detected. 115V 60 Hz, 20 amp. Not installed at factory. UL listed.
Cat. No. 50104

Fume Hood International Electrical Services (CE)

Continental European Socket with cover cap
Type: CEE7
color: gray
Rating 250V/16 amp, installed at factory.
Cat. No. 50004

Indian / South Africa Socket ISA
Type: BS546
color: white
Rating 250V/15 amp, installed at factory.
Cat. No. 50006

United Kingdom / Ireland Shuttered Socket
Type: BS1363
color: white
Rating 250V/13 amp installed at factory.
Cat. No. 50007

Continental European Panel Mount Socket
Type: CEE7
color: white
Rating 250V/15 amp installed at factory.
Cat. No. 50008

Fume Hood Sink and Plumbing Services

A complete line of sinks in epoxy resin, polypropylene, and stainless steel. We also offer a wide variety of plumbing accessories including neutralization tanks and bead baths. HEMCO welcomes the opportunity to quote your special applications. Additional sink sizes are available. Contact factory for more details. Conforms to ANSI Z21.15.

Epoxy Resin Fume Hood Laboratory Sinks



Epoxy Resin Sink Laboratory sink made of chemical and corrosion resistant epoxy resin. Drop-in sink. color: black. Please specify desired location. Includes sink stopper & drain outlet.

	Size	Cat. No.
1	9" x 6" x 6" deep	42021
2	16" x 12" x 8" deep	42022
3	18" x 15" x 11" deep	42026
4	24" x 16" x 8" deep	42027

Polypropylene Fume Hood Laboratory Sinks



Polypropylene Sink Laboratory sink made of chemical resistant heavy duty polypropylene. Drop-in sink. color: black. Please specify desired location. Includes drain outlet.

	Size	Cat. No.
1	12" x 8" x 8" deep	72041
2	14" x 10" x 6" deep	72043
3	18" x 15" x 12" deep	72045
4	28" x 20" x 9" deep	72048

Stainless steel Fume Hood Laboratory Sinks



Stainless Steel Sink Laboratory sink made of one-piece, type 304 stainless steel and polished to a No. 4 satin finish. Drop-in sink. Underside is sound deadened to reduce drumming. Specify location. Includes drain outlet.

	Size	Cat. No.
1	12" x 12" x 7.5" deep	42031
2	16" x 16" x 7.5" deep	42032
3	16" x 22" x 7.5" deep	42033
4	16" x 28" x 7.5" deep	42034

Fume Hood Cup Sinks & Plumbing Fixtures



Cupsink 6" Diameter

Cupsink is made of polyolefin with 1.5" IPS tailpiece and outlet strainer.
Cat. No. 40118



Oval Cup Sink

Drop-in cup sink available in polyolefin. 1.5" IPS tailpiece includes strainer.

3" x 6"	40119
3" x 9"	40121



Oval Wall Cupsink 6" x 3"

Cupsink is made of polyolefin with 1.5" IPS tailpiece and outlet strainer.
Cat. No. 40419



Jar P Trap

P-trap includes adjustable tailpiece and removable jar. with 1.5" IPS tail piece.
Cat. No. 40220



P Trap

P-trap is made of polypropylene with 1.5" IPS tailpiece.
Cat. No. 40120

Neutralization Tanks



15 gallon tank
(17.25" dia. x 15.5" H with 1.5" IPS inlet / outlet)

Cat. No. 40322

Note: 15 gallon tank requires (3) bags of limestone.

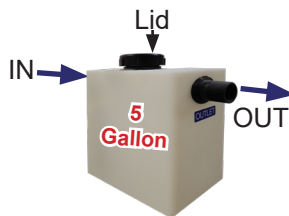

Molded of one-piece, chemical resistant polyolefin Neutralization tanks are designed to dilute and neutralize laboratory waste and concentrated corrosives.

5 gallon tank
(5.5" wide x 14" deep x 20" high with 1.5" IPS inlet / outlet)

Cat. No. 40222

Note: 5 gallon tank requires (1) bag of limestone.



LIMESTONE

Limestone is utilized as the medium for neutralizing the hazardous waste. (50 lb bag)

Note: Limestone is not included with tank.

Cat. No. 40223

Apparatus Grids and Fire Extinguishers

Distillation apparatus grids are designed to mount small apparatus and glassware in the interior of the fume hood, maximizing the work area. Grids are available in aluminum, stainless steel, or fiberglass to meet specific needs. Mounting options: 1. Grids can be mounted to the side walls of the fume hood, 2. When more strength is required, grids can mount to both the sidewalls and the worksurface, consult factory for details.

Fume Hood Apparatus Grids

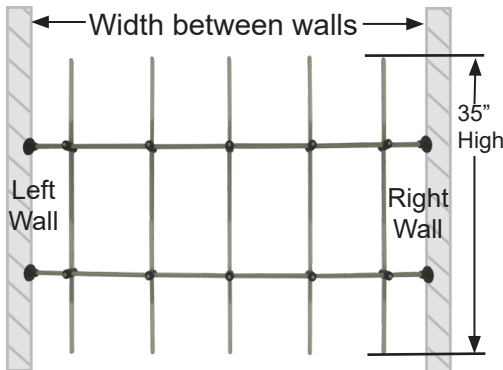

Fume hood with apparatus grid installed

Aluminum Apparatus Grid

Fume Hood Width	48"	60"	72"	96"
Grid Width for Hood as Installed	36"	50"	62.5"	86.5"
Aluminum Rod Assembly 1/2" dia.	50141	50151	50161	50181

- All components are machined from solid aluminum bar stock.
- All aluminum lattice rod components are furnished with a satin (brushed) finish.
- Backing plates for hood wall and mounting screws for flanges are not included.

Stainless Steel Apparatus Grid

Fume Hood Width	48"	60"	72"	96"
Grid Width for Hood as Installed	35"	46"	56"	81"
Stainless Steel Assembly 1/2" dia	50142	50152	50162	50182

- Stainless steel components offer superior strength and corrosion resistance for even the most demanding applications.
- All components are machined from Type 316 stainless steel bar stock and polished to a satin finish.
- Backing plates for hood wall and mounting screws for flanges are not included.

Non-Metallic Composite Apparatus Grid

Fume Hood Width	48"	60"	72"	96"
Grid Width for Hood as Installed	35"	46"	56"	81"
Fiberglass Rod Assembly 1/2" dia.	50143	50153	50163	50183

- All rod components are white fiberglass.
- All connectors are molded in black nylon for strength and chemical resistance.
- Backing plates for hood wall and mounting screws for flanges are not included.
- Half open style clamps, facilitate adding or removing rods from existing assembly.

Fire Extinguishers for Flammable Hazards in Fume Hood fume chamber

Foremost: Fume hood fires must be extinguished promptly, failure to do so could result in loss of life and valuable equipment & processes. In case of a fire inside of a fume hood. 1. Lower the sash into the closed position. 2. Pull the manual front mount discharge cable to activate the fire extinguisher. 3. Shut off the fume hood blower on the fume hood, and any remote exhaust blowers that are connected. 4. Shut off any utility services that could feed a fire. Fire extinguisher activation occurs at 165° Fahrenheit. These are recommendations, contact your laboratory safety officer for guidelines.

ABC Dry Chemical Fire Extinguishers



1. Fire Extinguisher with automatic activation at 165° Fahrenheit.
 - With dry chemical Monoammonium Phosphate, 10 lb.....Cat No. 53030

Halon Fire Extinguishers



2. Fire Extinguisher with automatic activation at 165° Fahrenheit.
 - With Halon, up to 50 Cubic feet.....Cat No. 53050
 - With Halon, 125 Cubic feet.....Cat No. 53125

- Manual Discharge Cable Kit.....Cat No. 53007

Manual discharge cable kit **Note:** Larger hoods may require (2) or more extinguishers, based on interior cubic dimensions.

HEMCO Fume Hood Materials & Chemical Resistance Chart

UniFlow Fume Hoods are constructed of white composite Fiberglass Reinforced Polyester (FRP) material. FRP is an excellent general purpose material for fume hood construction.



Superstructure features unitized dual wall construction with integral one-piece fume chamber for total chemical resistance, non-sparking construction, for hazardous locations.



- UniFlow HiPel FRP Composite construction is UL 1805 Classified for Laboratory Fume hoods and cabinets.
- HEMCO HiPel FRP Composite conform to NFPA 45 for products used in laboratories.
- To provide for the best airflow performance through the fume chamber, any heat generating equipment should be elevated 2" to 3" above work surface and 4" to 6" away from side walls and rear baffle system, and at least 6" away from the sash opening.

Chemical resistance of HEMCO's most widely used FRP composite construction, and other liner material options.

N = No Effect S = Slight Effect B = Bad Effect NA = Data Not Available

Chemical	HEMCO HiPel FRP Composite	Polyvinyl Chloride (PVC)	High Density Polyethylene (HDPE)	Polypropylene (PP)	304 Stainless Steel (SS)	316 Stainless Steel (SS)	Worksurfaces	
							Epoxy Resin	Phenolic Resin
Acetic Acid	N	N	NA	N	S	N	N	NA
Acetone	N	B	N	N	N	N	N	NA
Ammonium Hydroxide	N	N	NA	N	N	N	N (28%)	NA
Benzene	N	B	S	B	N	N	N	B
Carbon Tetrachloride	N	B	B	B	N	N	N	N
Chromic Acid	N	S	NA	B	N	N	S (40%)	B
Diethyl Ether	N	B	NA	B	N	N	N	NA
Ethyl Alcohol	N	N	N	N	N	N	N	NA
Gasoline	N	N	B	NA	N	N	N	N
Hydrogen Peroxide	N	N	N	N	NA	NA	N	B
Hydrochloric Acid	N	N	N	N	B	B	S	NA
Kerosene	N	N	NA	B	N	N	N	N
Methyl Alcohol	N	S	N	N	N	N	N	NA
Methyl Ethyl Ketone	N	B	B	NA	N	N	NA	N
Nitric Acid	N (20%)	N	N	B	B	B	N	NA
Sodium Chloride	N	N	N	NA	S (10%)	N (10%)	S (10%)	N
Sodium Hydroxide	N	N	N	N	N	N	S (10%)	B
Sodium Hypochlorite	N	N	B	N	N	N	N	NA
Sodium Sulfide	S	N	N	NA	N	N	NA	B
Sulfuric Acid	N (33%)	N (70%)	N (80%)	N	S (80%)	N (80%)	N (60%)	B (75%)
Sulfuric Acid (conc.)	S	S	S	N	B	S	B	B
Flame Spread	< 25	NA	NA	NA	0	0	NA	NA
Fuel Contributed	0	NA	NA	NA	0	0	NA	NA
Smoke Developed	500	NA	NA	NA	0	0	NA	NA

Laboratory Ventilation Recommendations

Proper placement and use of fume hoods and blowers are important laboratory ventilation requirements. HEMCO offers the following suggestions to help in your laboratory layout. For technical support please contact HEMCO.

Location of Hood

- Room air supply, air flow patterns and user convenience are the most important considerations in planning the location of hoods within the laboratory.
- Hoods placed directly in front of doors, open windows, or air conditioning registers will not perform efficiently. Drafts create turbulence at the face of the fume hood and disrupts air flow.
- Hoods should not be placed where users would be forced to work in the line of traffic. Traffic in front of the hood adversely affects fume hood air flow
- When common exhaust or supply systems are used for several hoods, the hood units should be arranged so minimum amount of ductwork is required. See page 17 for more suggestions on planning your ducting system.
- Hoods used as general lab exhaust should generally be located on the opposite wall from the side-wall inlet registers or doors. The hoods should be located so that air from the registers or diffusers sweep through the laboratory area first then into the hoods.

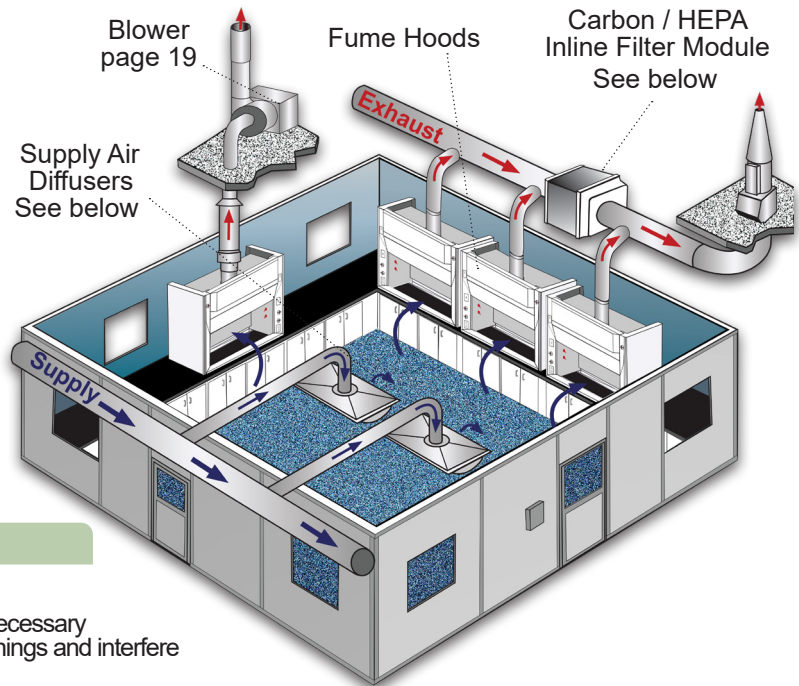

Hood Operation

- Consult Lab Safety Officer for correct use of fume hood.
- Hoods should not be used as laboratory storage space. Unnecessary material or unused bottles and flasks can block exhaust openings and interfere with hood performance.
- OSHA requires a fume hood be equipped with an Air Flow Monitor to track air flow velocities and warn operator of potentially dangerous low air flows due to damper, blower failure, blockage of ductwork system, or extreme sash opening height.

Fume Hood Radial Flow Supply Air Diffuser

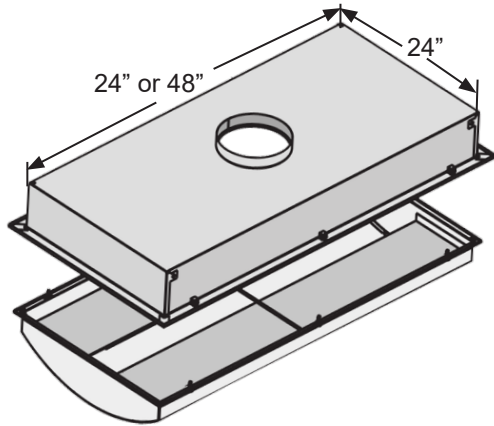

The Radial Flow Diffuser is designed to provide high volume / low velocity airflow into laboratory space specifically where fume hoods are located.

The uniform / low velocity airflow prevents turbulence at the hood face and efficiently distributes supply air to ensure correct air change that supports fume hood air volume requirements.

Available duct sizes: 8 or 10 inches for 24 x 24 inch models, and 10 or 12 inches for 48 x 24 inch models.

- 24" X 24" 200-500 CFM Cat. No. 90011
- 24" X 48" 400-1,000 CFM..... Cat. No. 90012

Clean Air In-Line Carbon and or HEPA Filtration Systems

HEPA Filter Paks effectively collect particulate contaminants from the exhaust air stream.

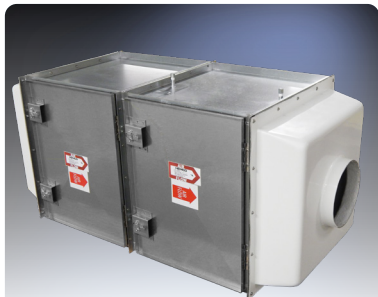

Filters can be grouped together end to end for HEPA and Carbon, or side by side for greater airflow volume. (Consult factory)

Clean Air Carbon Filter Pak

CFM	Size	Duct Size	Cat. No.
250-650	26" x 15" x 3.5"	4", 8" diameter	50297
650-1200	26" x 26" x 35.5"	8", 10", 12" diameter	50298

Carbon Filters

CFM	Size	Cat. No.	CFM	Size	Cat. No.
500	24" x 12" x 12"	52100	500	24" x 12" x 2"	52000
1000	24" x 24" x 12"	52101	1000	24" x 24" x 2"	52001

Prefilter (6 per carton)

Clean Air HEPA Filter Pak

CFM	Size	Duct Size	Cat. No.
250-650	26" x 15" x 35.5"	4", 8" diameter	50188
650-1200	26" x 26" x 35.5"	8", 10", 12" diameter	50189

HEPA Filters

CFM	Size	Cat. No.	CFM	Size	Cat. No.
500	24" x 12" x 12"	50094	500	24" x 12" x 2"	52000
1000	24" x 24" x 12"	50095	1000	24" x 24" x 2"	52001

Prefilter (6 per carton)

Energy Savings Recommendations

A comparison of two fume hoods below is based on a designed 12" high operating sash height with sash management and a full open sash height without sash management. By maintaining a lower operating height, energy can be conserved, material costs saved, and user safety enhanced. Sash Management can SAVE 57% on fume hood operating cost.

Energy Savings



1. UniFlow 72" CAV bypass fume hood **WITHOUT** sash management requires 1170 CFM to maintain 100 FPM (face velocity) with the sash fully open. At an average of \$7.00 per CFM, the annual cost to operate this fume hood would be \$8190.00

2. UniFlow 72" CAV bypass fume hood **WITH** sash management only requires 500 CFM to maintain 100 FPM (face velocity) with operating height at 14". At an average of \$7.00 per CFM, the annual cost to operate this fume hood would be \$3500.00

Total Energy SAVINGS = \$4690.00 per year

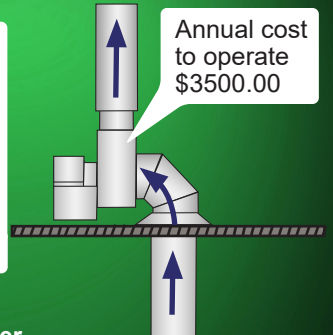

Equipment Savings

Based on 20' of ducting, (1) 90° elbow, stack outlet, and exhaust blower

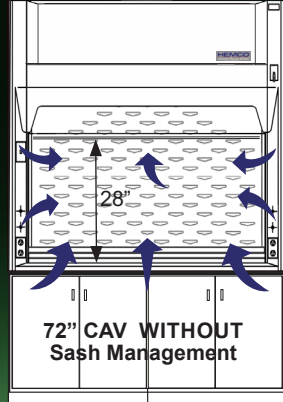

UniFlow 72" CAV bypass fume hood **WITHOUT** sash management would require 12" diameter ducting to handle the volume and duct velocity at \$200.00 per foot.

UniFlow 72" CAV bypass fume hood **WITHOUT** sash management an exhaust blower designed to maintain 100 FPM (face velocity) would require 1170 CFM @ 0.75" w.g. (static pressure) with a 10" diameter inlet and 1/2 hp motor at \$3720.00

UniFlow 72" CAV bypass fume hood **WITH** sash management would only require 8" diameter ducting to handle the volume and duct velocity at \$143.00 per foot.

UniFlow 72" CAV bypass fume hood **WITH** sash management an exhaust blower designed to maintain 100 FPM (face velocity) with sash at 14" operating height, would only require 500 CFM @ 0.75" w.g. (static pressure) with a 9" diameter inlet and 1/4 hp motor at \$3264.00

Total Equipment SAVINGS ducting & blower = \$1617.00

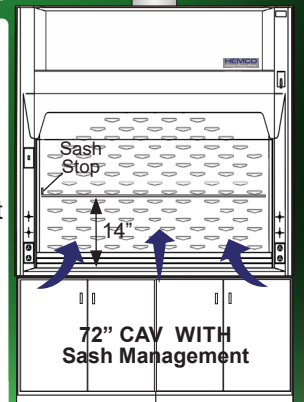

Importance of Duct Velocity

Duct Velocity is important to the safe ventilation of laboratory fumes & particulate, 1200 to 1500 FPM (duct velocity) is recommended. A 72" fume hood with 1170 CFM (for full sash opening) will have a 12" diameter belled outlet duct connection & will maintain 1400 FPM duct velocity. A 72" fume hood with 500 CFM (for 12" sash opening) will have an 8" diameter belled outlet duct connection & will maintain 1400 FPM duct velocity for over a 50% reduction in volume.

Importance of Room Air Changes per Hour

10-12 Air Changes per Hour is typical to a laboratory and in some cases the fume hood not only exhausts hazardous fumes but serves as the general ventilation of the lab. The lab should always be under negative pressure; thus 10% of the exhaust should come in from the corridor under or around the door. For example, a 12' x 25' x 9' high room, at 2700 cu ft, would require approximately 450 CFM. With the hood at 500 CFM and 10% of that coming from the corridor, the minimum supply in the room would be 450 CFM. However if a greater amount is brought in, there would need to be general exhaust from the room to prevent the room from being pressurized.

Make-Up Air, Considering that a fume hood exhausts a large amount of air from the lab space, it is necessary to ensure that there is sufficient air supply to the lab, yet still maintaining a negative air pressure to the surrounding area.

Because of the additional resistance in the duct system, the static pressure of inline filtration would need to be calculated when sizing the exhaust fan.

Filtration, Depending on the contaminant, an inline HEPA or carbon filter may be necessary to prevent pollution to the outside environment.

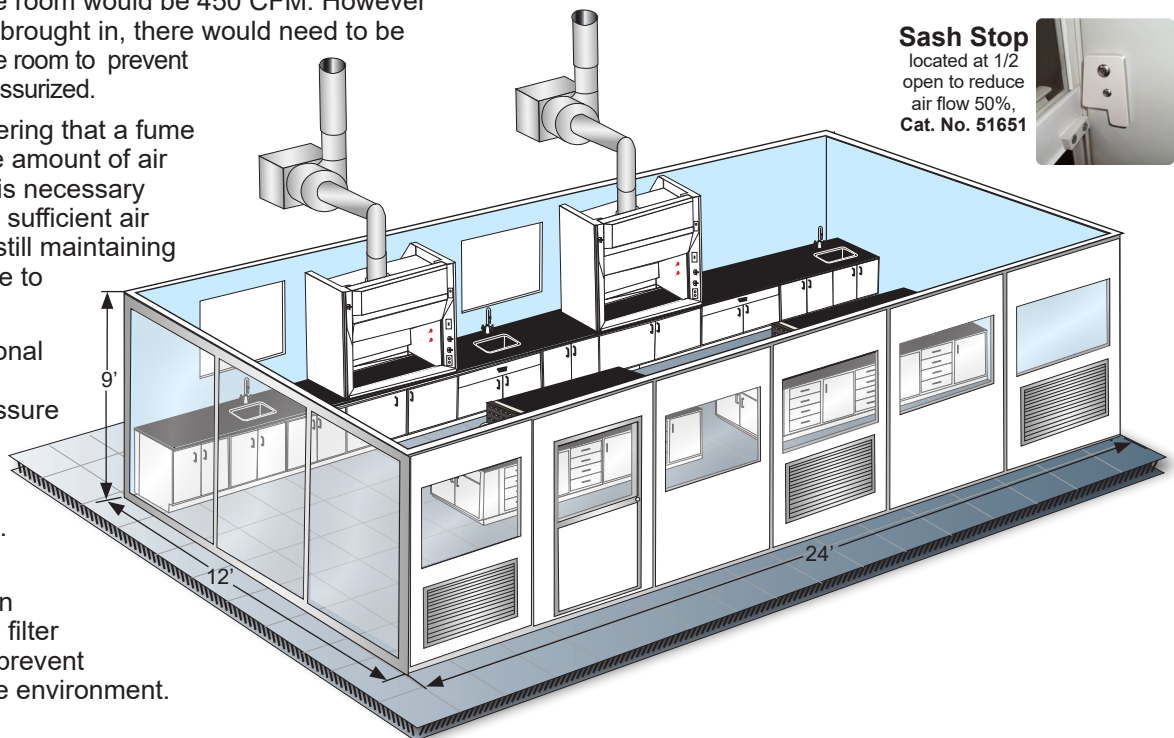

Fume Hood Ventilation and Duct Design

Ductwork connected to fume hoods may be arranged in a variety of patterns depending on requirements. Generally, the best exhaust system involves the shortest duct length and the fewest elbows. Duct size, length, and number of elbows affect static pressure loss and blower efficiency. Ideally, each fume hood should have its own ducting and blower to maximize hood flexibility and reduce danger of back draft from other hoods.

Common or manifold ductwork designs can be used, provided duct and blower have been sized properly. In these designs, individual hood dampers are recommended to balance the system. Hood users must be aware of how different hood exhaust fumes will react when mixed in the ductwork. Rigid PVC ductwork is recognized as an excellent fume hood exhaust duct material. The smooth interior surface reduces static pressure loss and chemical waste build up, and PVC is extremely resistant to a wide variety of reagents. For some applications flexible PVC lined duct provides adequate service and can significantly reduce installation costs. When planning exhaust ducting, duct size, length, number of bends, and exhaust material must be considered. Consult HEMCO for Lab Ventilation Solutions.

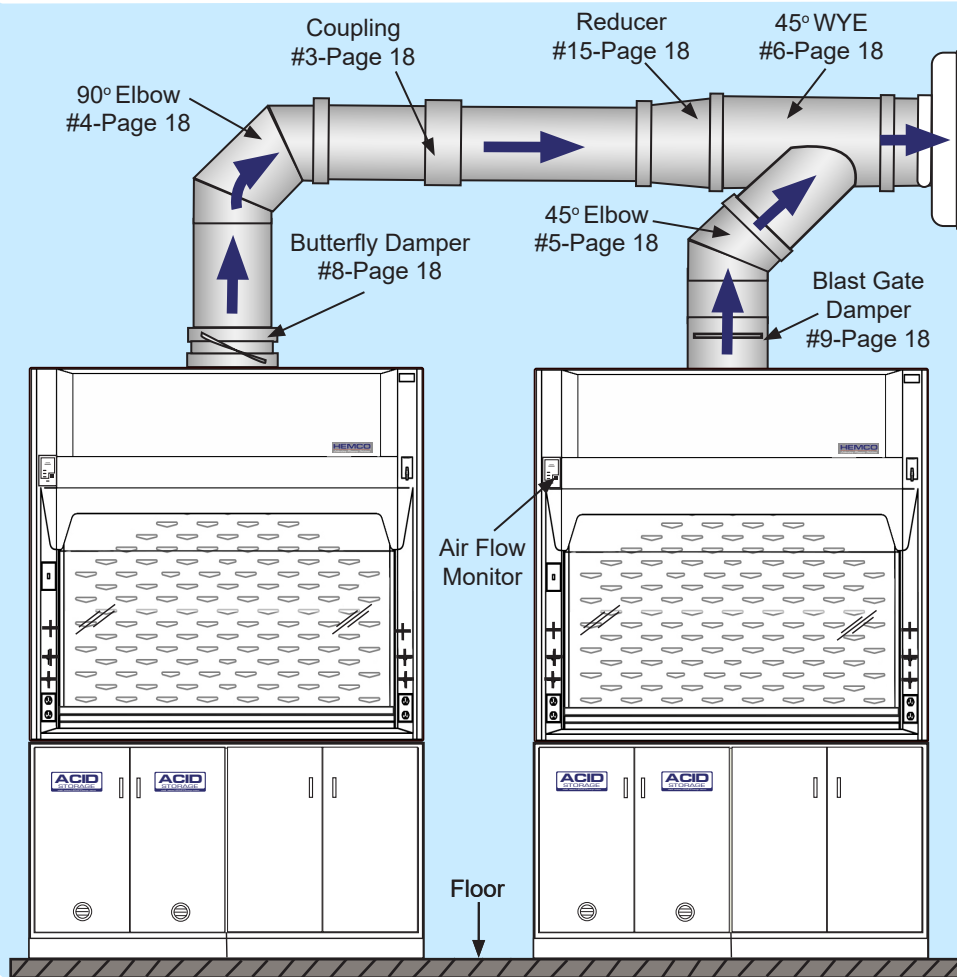
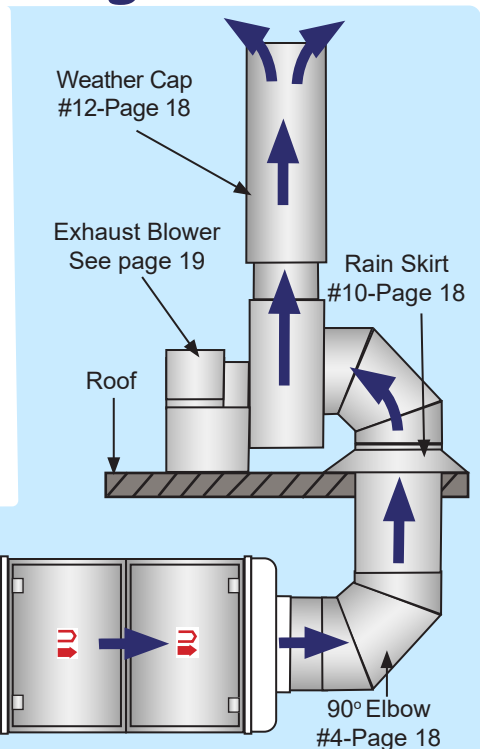

Air Flow Monitors
Note: OSHA recommends air flow alarms to be installed on all fume hoods.

Air Flow Monitor Analog
Continuously monitors face velocity air flow of fume hood. Select and calibrate at desired FPM velocity set point. If the hood face velocity falls below set point, an audible alarm sounds and a visual red indicator light appears. Air flow alarm is factory installed or can be field installed, 115/60Hz AC.
Cat. No. 51403

Air Flow Monitor with Digital Display
Continuously monitors face velocity air flow of fume hood. A digital display of face velocity in m/sec or FPM that indicates safety reading with an audible alarm. Push button calibration and 3 programmable input/output relays. Factory installed or can be field installed.
Cat. No. 51410

Air Flow Monitor Intrinsically Safe
For applications where the fume chamber is classified but the surrounding lab space is not. Continuously monitors face velocity air flow of fume hood. If the hood face velocity falls below set point, an audible alarm sounds and a visual red indicator light appears. Factory installed or can be field installed.
Cat. No. 51404



Minihelic Gauge
Gauge monitors the pressure across the HEPA filter. Gauge mounts on the fume hood or on the filter housing. Measure range is from 0 to 2.0" wg. accurate within 5%. Gauge is 3" dia.
Cat. No. 51300



Magnehelic Gauge
Gauge measures static pressure across the HEPA filter. Can mount on the fume hood or the filter housing. Range of measurement is from 0 to 2"wg. dia. accurate within 2%. Gauge is 5"
Cat. No. 51301















Mini Photohelic Gauge
Mini-Photohelic differential pressure gauge with two SPDT switching set points, is designed to measure and control positive, negative, or differential pressures consisting of noncombustible and non-corrosive gasses. Gauge is 3" dia.
Cat. No. 51302

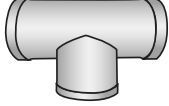

Digihelic Gauge
Gauge allows selection of pressure, velocity, or volumetric flow operation. Menu keys to access 5 menus which provide access to security level, selection of pressure, velocity of flow operation, and selection of engineering units. Gauge is 3" dia.
Cat. No. 51303

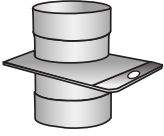
Fume Hood Ductwork & Venting Accessories

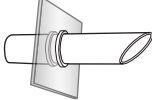
Ducting and accessories are chemical resistant and easy to install.

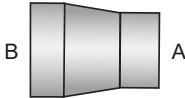
Flexible and Rigid PVC Ducting		4"	6"	8"	10"	12"	14"
	1. Flexible Ducting neoprene impregnated fiberglass reinforced with steel helix wire. Standard 12' lengths. Each piece includes 2 stainless steel clamps.	Cat. No. 80051	Cat. No. 80052	Cat. No. 80053	Cat. No. 80054	Cat. No. 80055	Cat. No. 80056
	2. PVC Rigid Ducting chemical resistant for permanent installations. Standard 10' lengths with straight ends.	Cat. No. 82004	Cat. No. 82006	Cat. No. 82009	Cat. No. 82011	Cat. No. 82013	Cat. No. 82015
	3. PVC Coupling required to connect straight sections.	Cat. No. 82147	Cat. No. 82149	Cat. No. 82153	Cat. No. 82157	Cat. No. 82159	Cat. No. 82160
	4. PVC 90° Elbow used in order to offset obstacles. Has belled ends for duct connections.	Cat. No. 82060	Cat. No. 82061	Cat. No. 82063	Cat. No. 82066	Cat. No. 82068	Cat. No. 82069
	5. PVC 45° Elbow used in order to offset obstacles. Less static pressure loss than a 90° elbow. Has belled ends for duct connections.	Cat. No. 82082	Cat. No. 82083	Cat. No. 82085	Cat. No. 82087	Cat. No. 82089	Cat. No. 82090
	6. PVC 45° WYE lateral for joining common ductwork in multiple hood designs. Branch diameter may be sized to 2" to 4" smaller than main diameter. Has belled ends for duct connections.	Cat. No. 82216	Cat. No. 82218	Cat. No. 82226	Cat. No. 82229	Cat. No. 82233	Cat. No. 82234
	7. PVC Tee used in manifold exhaust systems. Has belled ends for duct connections.	Cat. No. 82034	Cat. No. 82036	Cat. No. 82038	Cat. No. 82040	Cat. No. 82044	Cat. No. 82046
	8. PVC Butterfly Damper modifies CFM for single or multiple hood arrangement. Has belled ends for duct connections.	Cat. No. 82450	Cat. No. 82452	Cat. No. 82454	Cat. No. 82456	Cat. No. 82458	Cat. No. 82460
	9. PVC Blast Gate Damper a gate that slides in and out to control CFM. Has belled ends for duct connections.	Cat. No. 82369	Cat. No. 82371	Cat. No. 82373	Cat. No. 82375	Cat. No. 82377	Cat. No. 82379
	10. PVC Rain Skirt slips over straight pipe on roof to slope water away from cutout.	Cat. No. 82328	Cat. No. 82330	Cat. No. 82332	Cat. No. 82334	Cat. No. 82336	Cat. No. 82337
	11. PVC Vent Outlet for horizontal venting through wall or window. Angled end prevents rain from entering. Male connector included.	Cat. No. 80074	Cat. No. 80076	Cat. No. 80077	Cat. No. 80078	Cat. No. 80079	Cat. No. 80080
	12. Zero Pressure Weather Cap discharges fumes vertically away from roof. Self-draining. Minimal static pressure loss. This is the recommended weather cap.	Cat. No. 82350	Cat. No. 82352	Cat. No. 82354	Cat. No. 82356	Cat. No. 82358	Cat. No. 82359
	13. Round to Round Transition to smaller duct diameter. Diameter "A" - "B"	Cat. No. 82613 4"- 6"	Cat. No. 82615 6"- 8"	Cat. No. 82617 8"- 10"	Cat. No. 82619 10"- 12"	Cat. No. 82620 12"- 14"	Cat. No. 82621 14"- 16"

Fume Hood Exhaust Blowers Ordering Info

A complete line of belt and direct drive exhaust blowers that are chemical resistant & available in standard and explosion-proof models. HEMCO blowers are designed to operate effectively and efficiently to remove noxious & hazardous fumes. Standard 115V 60Hz & international electrical configuration of 220V 50Hz AC available.

Blower Recommendations

- Blowers should be mounted on the roof in-order that the ducting leading to the blower inlet is under negative static pressure. If exhaust blowers are mounted inside the building, all ducting connected to the blower outlet will be under positive static pressure, if a leak were to develop in the section of the duct inside the building, toxic and or hazardous fumes could be forced out of the ductwork and into that area of the building.
 - To achieve the lowest practical noise level in the exhaust system, we suggest that the following measurements be used when there is no conflict with other specifications of the system:
 - Use vibration isolators or mounting blower exhaust assembly.
 - Install a blower fan that will deliver the correct CFM and static pressure with the lowest practical impeller wheel RPM. If possible, use a duct size large enough to keep duct velocity under 1800 FPM velocity.
 - Use a flexible connection at the fan inlet to isolate mechanical transmission of noise from the ducting between the hood and the exhaust blower.
 - Exhaust blower system should be designed with the fewest possible elbows or other fittings. Use radius type elbows & avoid using square elbows. Use gradual tapered transitions where necessary, & avoid abrupt changes in configuration or cross sectional area.
 - When ordering an exhaust blower, specify the orientation of discharge desired. Vertical up blast discharge is the most common and will be supplied unless otherwise specified.
 - All fans are shipped with clockwise rotation when viewed from the motor end of the assembly.
 - For normal usage, the standard for both the blower housing and impeller wheel is epoxy coated.
 - Blowers used for hood exhaust at altitudes above 1,000 feet, may require a correction factor to provide the correct CFM and static pressure.
- Contact factory for details relating to your specific application.**

Epoxy Coated Steel Belt Drive Blowers

Standard (STD) belt drive steel blower and impeller wheel are epoxy coated for superior chemical resistance. Explosion-proof blowers (EXP) have epoxy coated, non-sparking aluminum impeller wheel. V-belt drive and adjustable pulleys permit field balancing. Seven discharge positions to suit installation. Weather housing is furnished. Motor has thermal overload protection. Specify: 115V single phase, 230V single phase, 230/460V three phase or 208V(consult factory). 1 year manufacturer's warranty

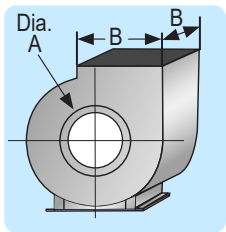

Catalog Number and Static Pressure														
cfm	A Inlet Diameter	B Outlet Size	1/2" Static Pressure			3/4" Static Pressure			1" Static Pressure			1 1/2" Static Pressure		
			HP	STD	EXP	HP	STD	EXP	HP	STD	EXP	HP	STD	EXP
296	8 7/8"	10 1/8" x 4 1/8"	1/4	51701	51801	1/4	51702	51802	1/4	51703	51803	1/4	51704	51804
474	8 7/8"	10 1/8" x 4 1/8"	1/4	51705	51805	1/4	51706	51806	1/4	51707	51807	1/2	51708	51808
652	8 7/8"	10 1/8" x 6 3/8"	1/2	51709	51809	1/2	51710	51810	1/2	51711	51811	1/2	51712	51812
800	8 7/8"	10 1/8" x 6 3/8"	1/2	51713	51813	1/2	51714	51814	1/2	51715	51815	3/4	51716	51816
914	9 7/8"	11 1/2" x 8 1/4"	1/2	51717	51817	3/4	51718	51818	—	—	—	—	—	—
1044	9 7/8"	11 1/2" x 8 1/4"	1/2	51719	51819	1/2	51720	51820	1/2	51721	51821	—	—	—
1175	9 7/8"	11 1/2" x 8 1/4"	1/2	51722	51822	1/2	51723	51823	3/4	51724	51824	—	—	—
1240	9 7/8"	11 1/2" x 8 1/4"	1/2	51725	51825	1/2	51726	51826	3/4	51727	51827	3/4	51728	51828
1240	11 7/8"	13 3/8" x 8 1/4"	1/3	51729	51829	1/2	51730	51830	—	—	—	—	—	—
1506	11 7/8"	13 3/8" x 8 1/4"	3/4	51731	51831	3/4	51732	51832	3/4	51733	51833	—	—	—
1771	11 7/8"	13 3/8" x 8 1/4"	1	51734	51834	1	51735	51835	1	51736	51836	1 1/2	51737	51837

Epoxy Coated Steel Direct Drive Blowers

Direct drive steel blower and impeller wheel are epoxy coated for superior chemical resistance. Explosion proof blowers have epoxy coated non-sparking aluminum impeller wheels. Motor is 115V, single phase and has thermal overload protection. 1 year manufacturer's warranty

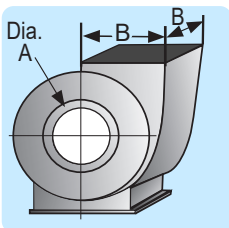

Catalog Number and Static Pressure								
A Inlet Diameter	B Outlet Size	HP	STD	EXP	1/4" SP	1/2" SP	3/4" SP	1" SP
					Free Air CFM	Free Air CFM	Free Air CFM	Free Air CFM
6"	7" X 4-3/8"	1/6	51177	51178	565	515	440	300
8"	8-3/4" X 5-7/16"	1/3	51179	51180	935	875	800	712
9"	10-1/8" X 4-1/8"	1/2	51181	51182	1050	980	920	850
9"	10-1/8" X 5-1/8"	3/4	51183	51184	1260	1220	1180	1100

Standard motors are 115V / 60Hz / 1 phase. Explosion proof motors are 115/230V, 60Hz, 1 phase. Other voltage, hertz, and phase motors are available.

Fume Hood Exhaust Blowers Ordering Info

HEMCO offers a complete line of chemical resistant non-metallic exhaust blowers in belt drive or direct drive options in standard or explosion proof models. Ideal for applications where corrosion resistance is critical. These blowers are available in polypropylene or fiberglass construction.

Blower Recommendations

1. It is recommended that exhaust blowers be located at the end of the ducting which is typically roof mounted. This ensures a negative pressure through out the ventilation system. However for applications where the duct is going directly out through a wall above a fume hood, one option is to have a fiberglass direct drive blower installed in the top of the fume hood. By having the blower internally mounted, the installation is simplified and convenient for duct connection and servicing. However there would be an airflow sound element associated to having the blower hood mounted.
2. By keeping the exhaust duct as short and as straight as possible, the total resistance will be reduced and by keeping the diameter of the duct correctly sized to the flow volume, noise and static pressure can be reduced.
3. Blower wheels for polypropylene and fiberglass blowers are polypropylene.
4. Vibration isolators are recommended when mounting the blower assemblies
5. HEMCO recommends that a sash stop be installed on the fume hood to limit the sash height for operation. By having stop at a half open position, the total CFM can be reduced by 50%; thus by reducing the volume, energy loss, duct diameter, motor and blower size, and sound is reduced.

UniFlow SE & LE Fume Hoods			
Hood Width	Hood Depth	Full Open CFM	1/2 Open CFM
36"	30"	438	241
48"	30"	772	385
60"	30"	938	474
72"	30"	1162	592
96"	30"	1613	800
UniFlow CE Fume Hoods			
Hood Width	Hood Depth	Full Open CFM	1/2 Open CFM
30"	24"	378	189
36"	24"	460	230
48"	24"	654	327
72"	24"	960	480

Blower Description

- CFM at 100 FPM face velocity
- Housing is constructed of either molded composite or polypropylene for chemical resistance.
- Flange inlet collars enable easy connection to ductwork.
- Wheel is dynamically balanced to minimize noise and increase efficiency.
- Belt drive models have Ball bearing pillow blocks which are pre-lubricated and resistant to both moisture and dirt.
- Shaft is constructed of polished steel with a coating to prevent rust and corrosion.
- Motors meet NEMA standards for single speed motors.
- These blowers are ideally suited for both supply and exhaust applications in laboratories, educational, pharmaceutical, industrial, and other applications.

Polypropylene Belt Drive Blowers



High efficiency impellers produce low power consumption, reduced operating costs and quiet operation. 20 forward curved blades, in fire retardant polypropylene. Non-static and oil resistant V-belt, cast iron pulleys, adjustable pulleys available, adjustment for tensioning and belt replacement. 230V explosion proof, non sparking, chemical resistant for hostile or hazardous environments. 115V single phase or three phase.

Non-static and oil resistant V-belt, cast iron pulleys, adjustable pulleys available, adjustment for tensioning and belt replacement. 1 year manufacturer's warranty

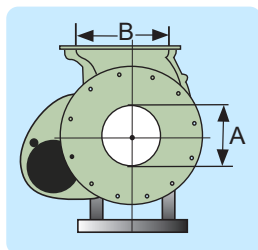

Catalog Number and Static Pressure											
Free Air CFM	A Inlet Diameter	B Outlet Diameter	0.5" Static Pressure HP			0.75" Static Pressure HP			1.0" Static Pressure HP		
			HP	STD	EXP	HP	STD	EXP	HP	STD	EXP
400	6"	6"	1/4	51450	51850	1/4	51460	51860	1/4	51470	51870
800	8"	8"	1/4	51451	51851	1/3	51461	51861	1/3	51471	51871
1000	8"	8"	1/2	51452	51852	1/2	51462	51862	1/2	51472	51872
1200	10"	10"	1/2	51453	51853	1/2	51463	51863	1/2	51473	51873
1600	10"	10"	1	51754	51854	1	51464	51864	1	51474	51874

HEMCO Plan-A-Lab Worksheet showing Groupings

The HEMCO Plan-A-Lab enables you to conveniently lay out your lab furniture and your pre-engineered modular clean lab. For more information request the Modular Clean Room Brochure. Shown below is a 20' X 24' (2) wall system. Existing walls in black, new walls in yellow slash mark.

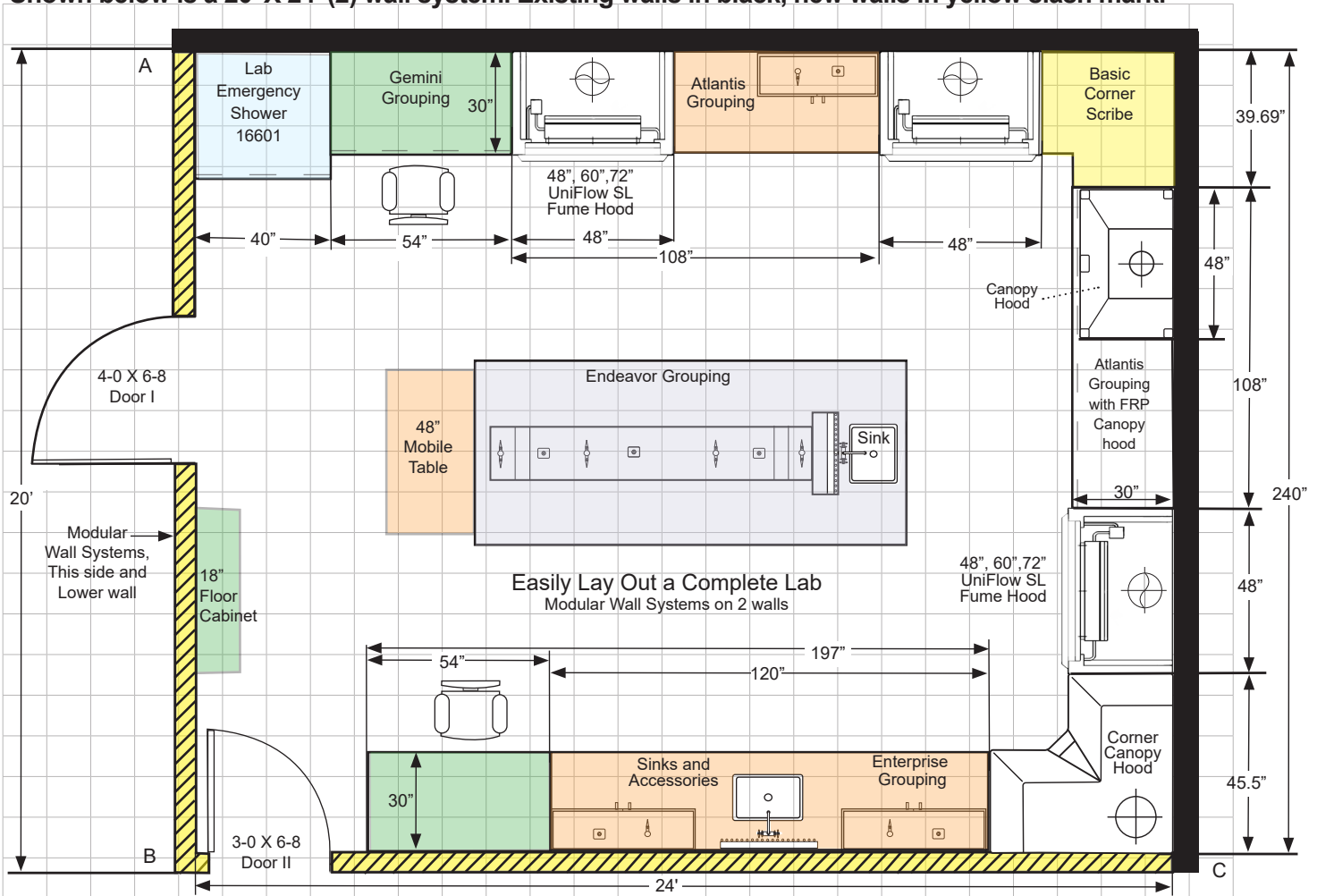

For Lab Planning worksheet visit: www.hemcocorp.com/images/Literature/PlanALab.pdf shown above 20' X 24' (2) wall system

UniLine Laboratory Casework Construction (SEFA 8 Compliant)



UniLine Casework is constructed of welded 18 gauge steel. Powder coat finish is environment friendly, attractive and long lasting, color: Lab White. Modular design allows for simple field conversion from inlet to overlay, door and drawer re-configurations and hardware component changes. Casework is tested independently to be SEFA 8 load bearing capacity compliant.



Rear Filler Panel
Cat. No. 74112

48" Cabinet
Cat. No. 71064
epoxy, stainless steel and phenolic worksurfaces available

Drawer Bodies constructed of 20 gauge steel. 18 gauge drawer suspension with full extension ball bearing drawer slide. File drawer suspension available in both 100 and 150 lb capacity. Exterior is urethane powder coated steel, for chemical and abrasion resistance.

Doors double wall construction with 20 gauge reinforcing channel (1) per door. Rubber door bumpers (4) per door. Five knuckle hinges (2) per door. Nylon roller catch (1) per door. Urethane powder coated steel. Manual, self closing.

Cabinet Interior Full length & width adjustable 20 gauge steel shelf for maximum storage. Zinc plated adjustable steel shelf clips. Powder coated finish for chemical resistance. 18 gauge full height removable access panel. Color: Lab White

Recessed Toe Space promotes laboratory cleanliness. Cabinet base lower corner reinforcing gusset with 0 to 2-1/2" zinc leveling bolts on (all four corners). Cabinet height adjustable from 35" to 37". 12 gauge steel corner gusset (4) each cabinet.

Laboratory Furniture Groupings

UniLine design incorporates our most popular casework groupings to meet your laboratory needs. Welded steel with chemical resistant, epoxy powder coat finish, and 1" thick phenolic resin countertops, 4" high backsplashes, and flush ends standard. Standard height 36", ADA height 34", and sitting height 28" options are available. Standard color: Lab White. (optional colors are available as required) Groupings can be supplied with optional Fume hoods.

Atlantis Grouping

Atlantis Grouping provides basic lab storage & a versatile work area. Cabinet grouping includes 3 standing height cabinets with rear filler panels on both ends, phenolic resin worksurface 36" high, with 4" high back splash. Includes 16" X 12" X 8" sink and H/C gooseneck faucet.

Atlantis Cabinet Grouping					
Width	1	2	3	24" Depth Cat. No.	30" Depth Cat. No.
9'	36"	36"	36"	70011	70021
10'	48"	36"	36"	70012	70022
12'	48"	48"	48"	70013	70023

Enterprise Grouping

Enterprise Grouping provides a convenient balance of storage and work space. Cabinet grouping includes 3 standing height cabinets with rear filler panels, 2 wall cabinets, phenolic resin worksurface 36" high, with 4" high back splash. Includes 16" X 12" X 8" sink, 30" X 30" pegboard and H/C gooseneck faucet.

Enterprise Cabinet Grouping					
Width	1	2	3	24" Depth Cat. No.	30" Depth Cat. No.
9'	36"	36"	36"	70211	70221
10'	36"	48"	36"	70212	70222
12'	48"	48"	48"	70213	70223

Endeavour Island Grouping

Endeavour Grouping is a flexible design that can serve as an island or peninsula layout. Cabinet grouping includes either 3 or 7 standing height cabinets with front and end filler panels, phenolic resin worksurface, and center island reagent shelf with pedestals and phenolic resin shelf. Includes 16" X 12" X 8" sink, 30" X 30" pegboard and H/C gooseneck faucet.

Endeavor Cabinet Grouping					
Width	1	2	3	4	Cat. No.
8'5"	36"	36"	—	60"	71311
11'5"	36"	36"	36"	60"	71312
14'5"	48"	48"	48"	60"	71313

Viking/Magellan Grouping

Viking Grouping is ideal for medical examination rooms and small lab requirements. Cabinet grouping includes 1 or 2 standing height cabinets, 1 wall cabinet 36" or 48" wide, 24" high 12" deep, phenolic resin worksurface. Includes 16" X 12" X 8" sink and H/C gooseneck faucet.

Viking Cabinet Grouping				
Width	1	2	24" Depth Cat. No.	30" Depth Cat. No.
6'	36"	36"	70413	70423
8'	48"	48"	70414	70424

Magellan Sink Cabinet Grouping			
Width	1	24" Depth Cat. No.	30" Depth Cat. No.
36"	36"	70611	70621
48"	48"	70612	70622

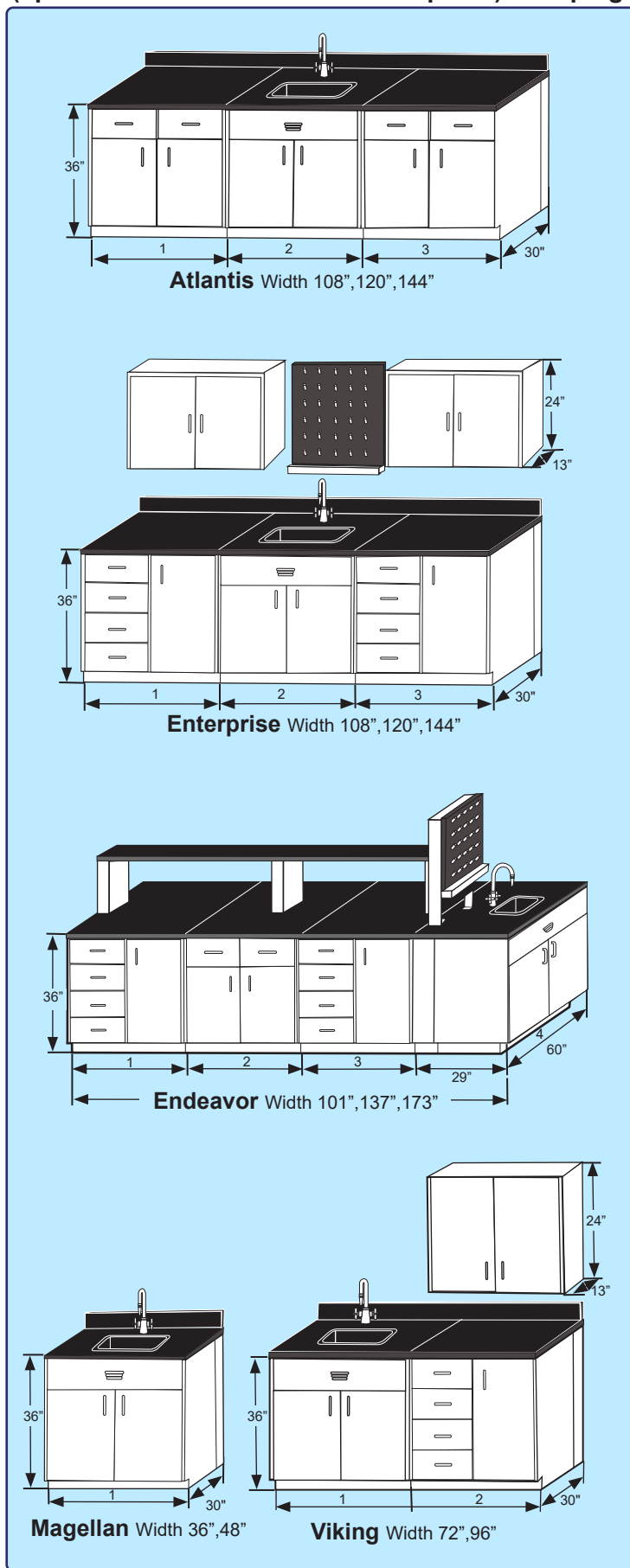

UniLine Furniture Groupings

Unitized design incorporates our most popular casework groupings to meet your laboratory needs. Welded steel with chemical resistant, epoxy powder coat finish, and 1" thick phenolic resin worksurface, 4" high backsplashes, and flush ends standard. ADA height 34" Max, and sitting height 28", options are available. Standard color: Lab White (optional colors are available as required)

Artemis Grouping

UniLine Artemis Grouping provides ample lab storage with options. Cabinet grouping includes (3) 36" high cabinets, phenolic resin worksurface, with 4" high back splash. Includes 16" X 12" X 8" sink and H/C gooseneck faucet, and three wall cabinets. Add a UniFlow SL fume hood in widths of 48", 60", 72", and 96" wide

Artemis Cabinet Grouping					
Cat.No.	Length	1	2	Add a hood Select 48", 60", 72" or 96" SL	3
70901	108"	36"	36"		36"
70902	144"	48"	48"		48"

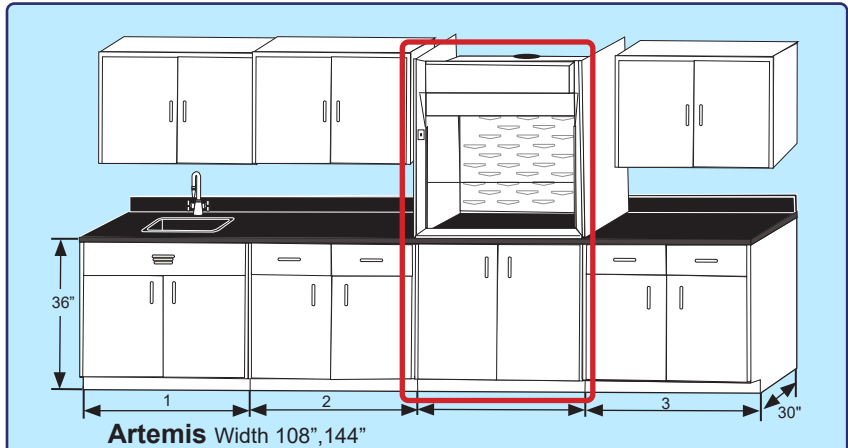

Ranger Grouping

UniLine Ranger Grouping combines convenient basic lab storage. Grouping includes (3) 36" high cabinets with rear filler panels on both ends, phenolic resin worksurface with 4" high back splash. Add a UniFlow SL fume hood in widths of 48", 60", 72", and 96" wide

Ranger Cabinet Grouping					
Cat.No.	Length	1	Add a hood Select 48", 60", 72" or 96" SL	2	3
70911	108"	36"		36"	36"
70912	144"	48"		48"	48"

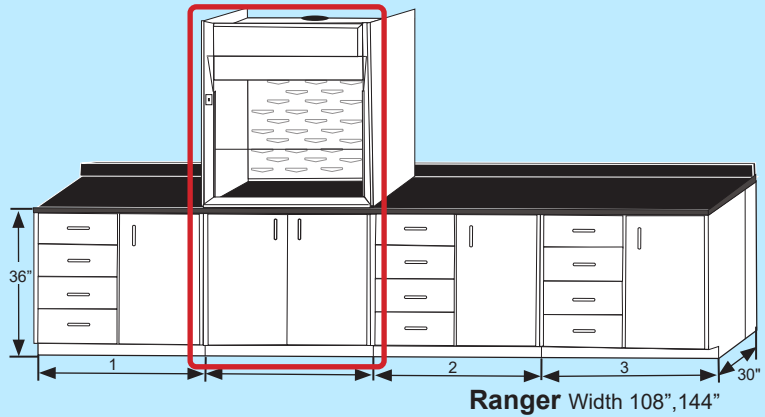

Surveyor Grouping

UniLine Surveyor Grouping accommodates greater storage requirements. Grouping includes (3) cabinets 36" high, phenolic resin worksurface with 4" high backsplash, 16" X 12" X 8" sink, H/C gooseneck faucet and pegboard. Add a UniFlow SL fume hood in widths of 48", 60", 72", and 96" wide

Surveyor Cabinet Grouping					
Cat.No.	Length	1	2	3	Add a hood Select 48", 60", 72" or 96" SL
70921	108"	36"	36"	36"	
70922	144"	48"	48"	48"	

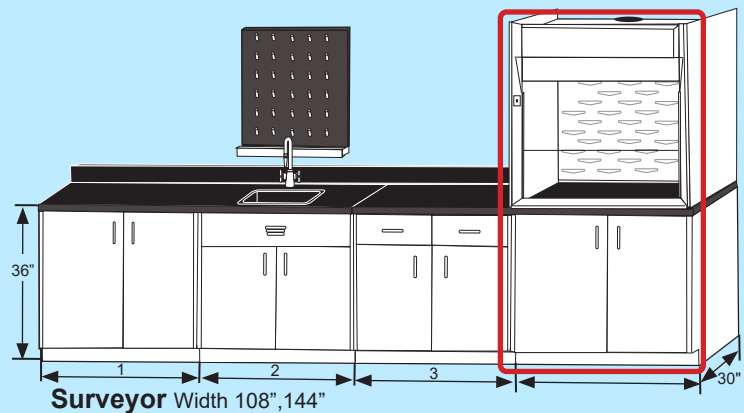

Lunar Grouping

UniLine Lunar Grouping provides lab storage. Cabinet grouping includes (3) 36" high cabinets with rear filler panels on the ends, and one floor storage cabinet, phenolic resin worksurface with 4" high back splash. Includes two wall cabinets. Add a UniFlow SL fume hood in widths of 48", 60", 72", and 96" wide

Lunar Cabinet Grouping					
Cat.No.	Length	Add a hood Select 48", 60", 72" or 96" SL	1	2	3
70931	108"		36"	36"	36"
70932	144"		48"	48"	48"

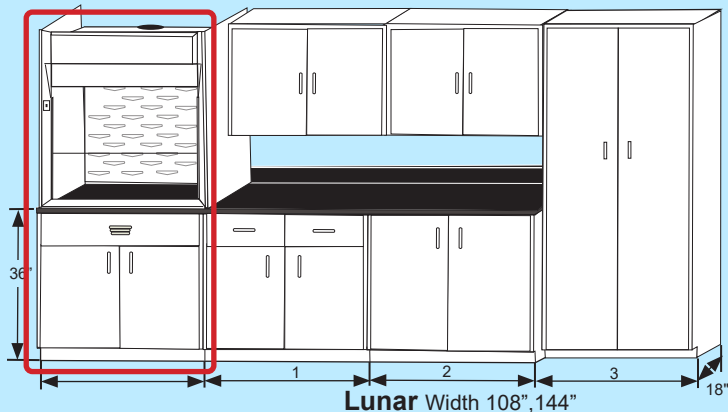

UniLine Furniture Groupings

Unitized design incorporates our most popular casework groupings to meet your laboratory needs. Welded steel with chemical resistant, epoxy powder coat finish, and 1" thick phenolic resin worksurface, 4" high backsplashes, and flush ends standard. ADA and sitting height options are available. Standard color: Lab White (optional colors are available as required)

Gemini Grouping

UniLine Gemini grouping features a sitting height desk area that can be incorporated with any of the HEMCO groupings. Cabinet grouping includes one sitting height file drawer cabinet with knee space panel, single apron, and phenolic resin worksurface. Sitting height 28".

Length	1	2	24" Depth Cat. No.	30" Depth Cat. No.
48"	30"	18"	70501	70521
54"	36"	18"	70502	70522
66"	48"	18"	70503	70523

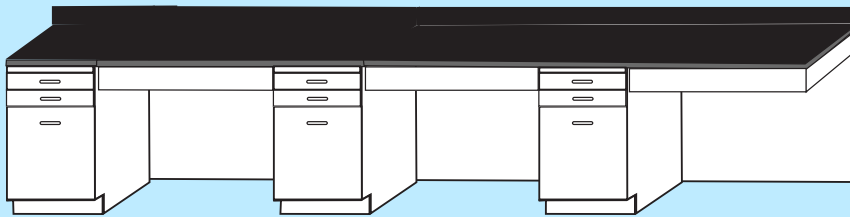

Example of (3) Gemini Groupings

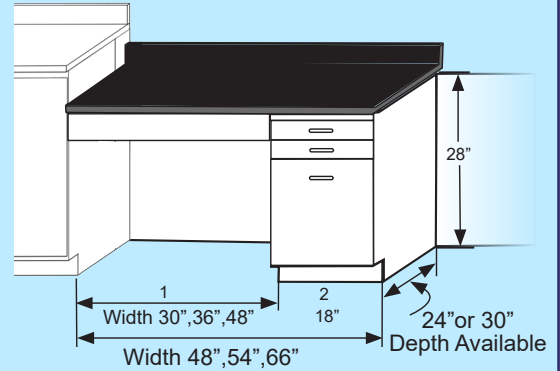

ADA

Freedom (ADA) Grouping Option

When ADA requirements are necessary, the UniLine Freedom Grouping option allows you specify any HEMCO casework grouping and be compliant to all dimension, space, and access standards as specified by ADA. In addition, all electrical services, plumbing accessories and safety equipment including emergency showers and eye wash stations are designed to meet ADA guidelines. Counter top height is 34". For ADA recommended reach see diagram 1 and 2.

Simply add "ADA" as a suffix to any HEMCO part number and HEMCO can design, quote, and supply ADA compliant equipment. Proper planning eliminates/reduces future problems. For a complete guide for all ADA technical information, including dimensions and standards, please visit: www.access-board.gov.

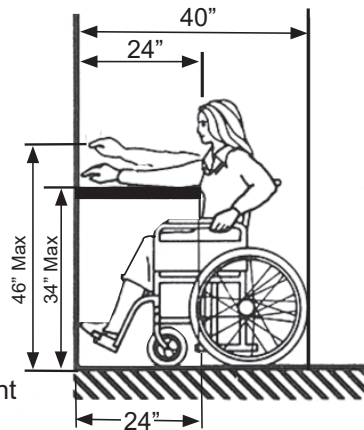

Diagram #1
Reach In

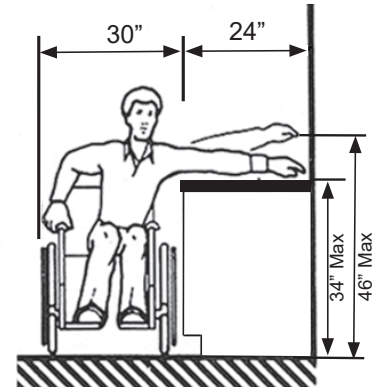
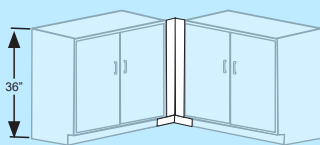

Diagram #2
Reach Over

Corner Grouping Solutions

HEMCO corner cabinets and fillers offer several means by which casework groupings or individual cabinets can be connected at a corner, eliminating unused corner space.



Basic Corner Scribe with worksurface
2" Cat. No. 74002

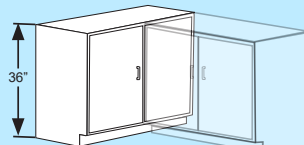

Overlap Corner Cabinet
36" Cat. No. 71981
48" Cat. No. 71983

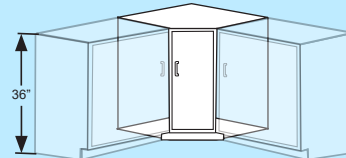

Spacious Corner Cabinet with worksurface
Cat. No. 71901

Corner Canopy



Corner Canopy Hoods

UniLine Base Cabinets

Lab cabinets are offered in standard modular sizes that allow you to create a custom laboratory to meet your specific needs. Cabinets feature furniture grade welded steel construction with a durable, chemical resistant, epoxy powder coat finish that meet or exceed SEFA 8, recommended practice for laboratory casework. Standard color: Lab White (optional colors are available as required) (Available in Stainless Steel or Polypro) (and ADA heights).

Base Cabinets (cabinets in boxes are in stock)

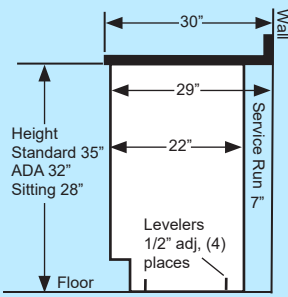

Cabinet End View

3 Drawer

Width	Cat. No.
18"	70701
24"	70702

For Gemini Groupings

4 Drawer

Width	Cat. No.
18"	71221
24"	71222

1 Drawer - 1 Door

Width	Cat. No.
18"	71181
24"	71182

Specify left or right hinged

1 Door

Width	Cat. No.
18"	71951
24"	71952

Specify left or right hinged

2 Drawer - 2 Door

Width	Cat. No.
30"	71061
36"	71062
48"	71064

1 Drawer - 2 Door

Width	Cat. No.
30"	71051
36"	71052
48"	71054

5 Drawer - 1 Door

Width	Cat. No.
30"	71131
36"	71132
48"	71134

4 Drawer - 1 Door

Width	Cat. No.
30"	71101
36"	71102
48"	71104

optional Acid Cabinet on door side

4 Drawer - 2 Door

Width	Cat. No.
30"	71081
36"	71082
48"	71084

5 Drawer

Width	Cat. No.
30"	71231
36"	71232
48"	71234

8 Drawer

Width	Cat. No.
30"	71241
36"	71242
48"	71244

6 Drawer

Width	Cat. No.
30"	71381
36"	71382
48"	71384

4 Drawer

Width	Cat. No.
30"	71211
36"	71212
48"	71214

Vacuum Cabinet

Width	Cat. No.
30"	71821
36"	71822
48"	71824

Base Cabinet

Width	Doors	Cat. No.
24"	1	52411
30"	2	53011
36"	2	53611
48"	2	54811
60"	2	56011

Acid Cabinet

Width	Doors	Cat. No.
24"	1	15240
30"	2	15300
36"	2	15360
48"	2	15480
Vent Kit	---	81000

Flammable Cabinet

Width	Cat. No.
24"	18020
30"	18300
36"	18030
48"	18040
Vent Kit	81000

Sink Unit Cabinet

Width	Cat. No.
24"	71810
30"	71811
36"	71812
48"	71814
60"	71815

Sink End Unit

Width	Cat. No.
52"	71881
58"	71882

Wall Cabinets, Floor Cabinets, and Accessories

Wall Cabinets

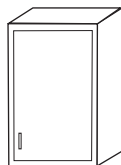

Single Door Wall Cabinet

Width	Height	Depth	Cat. No.
18"	30"	13"	72171
24"	30"	13"	72172
Specify left or right hinged			

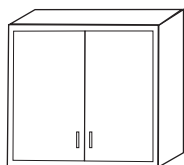

2 Door Wall Cabinet

Width	Height	Depth	Cat. No.
30"	30"	13"	72031
36"	30"	13"	72032
48"	30"	13"	72034

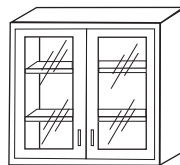

2 Door Framed Glass Cabinet

Width	Height	Depth	Cat. No.
30"	30"	13"	72061
36"	30"	13"	72062
48"	30"	13"	72064

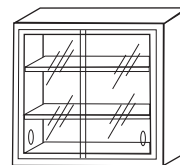

2 Glass Sliding Door Cabinet

Width	Height	Depth	Cat. No.
30"	30"	13"	72191
36"	30"	13"	72192
48"	30"	13"	72194

Floor Mounted Cabinets (Standard color: Lab White)

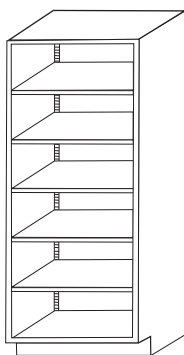

Floor Cabinet Open Front

Storage cabinet with 5 adjustable shelves. Height 84", Depth 18"

Width	Cat. No.
30"	73381
36"	73382
48"	73384

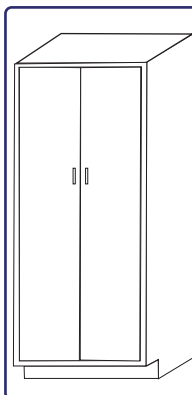

Floor Cabinet Solid Hinge Door

Storage cabinet with 5 adjustable shelves. Height 84", Depth 18"

Width	Cat. No.
30"	73321
36"	73322
48"	73324

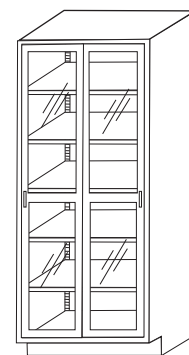

Floor Cabinet Slide Glass Door

Storage cabinet has glazed 1/4" glass doors and 5 adjustable shelves. Height 84", Depth 18"

Width	Cat. No.
30"	73371
36"	73372
48"	73374

Casework Accessories (Standard color: Lab White)

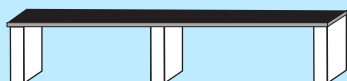

Reagent Shelf

Shelves are 4" wide 12" deep and 16" high. For use on island, peninsula, or against wall. Phenolic Resin shelf is 1" thick & 14" deep

Length	Cat. No.
6'	75111
9'	75112
12'	75113



Single Drawer Apron

4 1/2" high. Used to span knee space area and support countertop.

Width	Depth	Cat. No.
30"	22"	74031
36"	22"	74032
48"	22"	74034



Wall Shelf

8" deep. Includes vertical flanges for mounting.

Width	Cat. No.
24"	75911
30"	75912
36"	75913
48"	75914

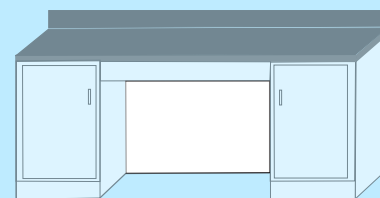

Knee Space Panel

35" high. Located at the rear of knee space areas.

Width	Cat. No.
24" to 36"	73261
36" to 48"	73262
54" to 66"	73263



End Panel

35" high x 22" or 28" deep. Used to support countertops at the end or middle of a knee space area. Please specify depth.

Cat. No. 73255

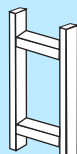

Leg Assembly

35" high x 22" or 28" deep. Used to support countertops at the end or middle of a knee space area. Please specify depth.

Cat. No. 73355



Front Rail

2" high x 30", 36" or 48" wide. Used to support countertops above knee space areas. Please specify width.

Cat. No. 74015



Cabinet Lock

Five-Disc tumbler door & drawer cam lock & (2) keys.

Cat. No. 75001



Utility Chase

24" wide x 6" deep x 84" high. Located on an island behind a sink. Used to conceal piping and to serve as mounting for pegboard.

Cat. No. 75091

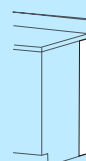

Rear Filler Panel

35" high x 7" wide. Used to enclose pipe chase behind cabinets on standard 30" deep counters.

Cat. No. 74112

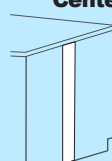

Center Filler Panel

35" high x 4", 10", or 14" wide. Used to enclose the pipe chase at the end of an island. Please specify width.

Cat. No. 74122

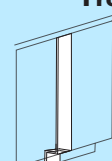

Front Filler Panel

35" high x 2", 6", or 12" wide. Used to enclose the space between cabinets to meet casework length requirement. Please specify width.

Cat. No. 74142

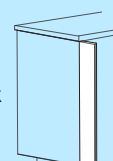

End Scribe

35" high x 2", 6", or 12" wide. Used to fill the space between the end of casework and a wall. Please specify width.

Cat. No. 74001

EnviroMax Vented Exhaust Enclosures

EnviroMax Vented Exhaust Enclosures protects personnel & containment processes

A Vented Exhaust Enclosure in Unitized & Modular Designs for exhausting fumes from Robotic & Automated processes

Designed to protect personnel from potentially hazardous fumes, vapors and odors. The enclosure can connect to in-house exhaust system or a dedicated exhaust blower, to provide the internal negative pressure needed to safely remove hazardous fumes from the work area. Air supply into the enclosure is supplied from the surrounding lab environment.

EnviroMax Options

- Access on any or all sides • Multi-Plug strips • Exhaust blowers • Vertical slide or hinged doors • Base cabinets • Exhaust HEPA or carbon filters • Other materials of construction • Anodized aluminum & stainless steel framing • Plumbing and electrical service fixtures • Airflow Monitors • Support benches & work surfaces • Accessories

For more information request the **EnviroMax Enclosures for Robotic and Automated Lab Processes Brochure**.

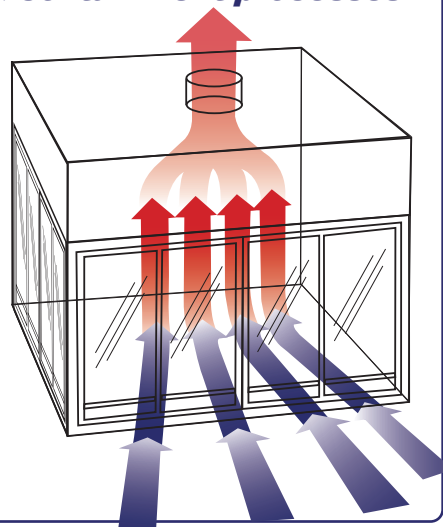

Unitized Construction Sizes			
Width	Depth	Height	Cat. No.
48"	30"	48"	61041
60"	30"	48"	61051
72"	30"	48"	61061
96"	30"	48"	61081
48"	36"	48"	61042
60"	36"	48"	61052
72"	36"	48"	61062
96"	36"	48"	61082

Unitized EnviroMax Vented Exhaust Enclosure sizes 4', 5', 6', and 8' wide by 30" & 36" deep by 48" high

Unitized design with depth of 30" and 36" to allow passage through door ways for easy on-site setup. Viewing from all four sides of the enclosed system. Access to interior of enclosure, available from any or all sides. Vent duct sized to airflow requirements. Pre-wired electrical connection to single point junction box. Under the bench storage and shelving designed to suit your requirements. Note: Custom sizes are welcomed.



Project: National Forensics & Coroners Complex, Canada
EnviroMax enclosure, unitized 120" wide X 36" deep X 48" high, with custom acid storage cabinets

Unitized EnviroMax Vented Exhaust Enclosure

Superstructure is welded steel framework with chemical resistant white powder coated finish. Side and rear walls are of clear acrylic or tempered glass. Ceiling is constructed of molded composite resin with the outlet duct connection collar sized for desired air volume. Slotted ceiling baffle allows air to flow evenly through the interior area into the exhaust plenum. The front of the enclosure features horizontal sliding shatter-proof clear viewing panels, (4) panels on (2) tracks allowing access at any position. Fluorescent light is factory installed and sealed behind a clear lens. Light switch is mounted on the front post. Provides an economical and flexible work space that exceeds stringent contamination requirements. All electrical components are U.L. listed.

Modular Construction Sizes			
Width	Depth	Height	Cat. No.
72"	48"	48"	62061
96"	48"	48"	62081
120"	48"	48"	62101
144"	48"	48"	62121
72"	60"	48"	62062
96"	60"	48"	62082
120"	60"	48"	62102
144"	60"	48"	62122

Modular EnviroMax Vented Exhaust Enclosure sizes 6', 8', 10' & 12' wide by 48" & 60" deep by 48" high

Modular design with depth of 48" or 60" requires on-site assembly prior to setup and vent ducting. Pre-wired electrical connection to single point junction box. Work surface and support benches and cabinets sized to specifications. Provides an environment free of contamination for sensitive processes. Note: Custom sizes are welcomed.



Project: National Forensics & Coroners Complex, Canada
EnviroMax Modular enclosure size: 60" wide X 60" deep X 120" high with work surface & 60" wide X 60" deep X 24" high support table

Modular EnviroMax Vented Exhaust Enclosure

Superstructure is welded steel framework with chemical resistant white powder coated finish. Side and rear walls are of clear acrylic or tempered glass. Ceiling is constructed of molded composite resin with the outlet duct connection collar sized for desired air volume. Slotted ceiling baffle allows air to be drawn out evenly across the width of the interior into the exhaust plenum. The front of the enclosure features horizontal sliding tempered glass panels, (4) panels on (2) tracks allowing access at any position. Fluorescent light is factory installed and sealed behind a clear lens. Light switch is mounted on the front header panel. All electrical components are U.L. listed.

EnviroMax HEPA Laminar Flow Workstations

EnviroMax HEPA Filtered Clean Work Enclosures Laminar Flow Benches protects processes

HEPA Filtered Enclosure offered in Unitized & Modular Design for Class 100 Clean Work Station

Specifically engineered to meet critical clean specifications by isolating equipment and procedures. The HEPA filtration eliminates particles 0.3 or larger to an efficiency of 99.995%, class 100 laminar airflow maintains a sterile work zone. Filters and lighting are conveniently changed from inside the enclosure. Optional U.V. lighting, anti-static and grounding options are available.

EnviroMax HEPA Filtered Options

- Access on any or all sides • Multi-plug strips • Magnehelic gages • cord port • base cabinets • Other materials of construction • Anodized aluminum & stainless steel framing • Electrical and key lock services • Support benches & Work surfaces •

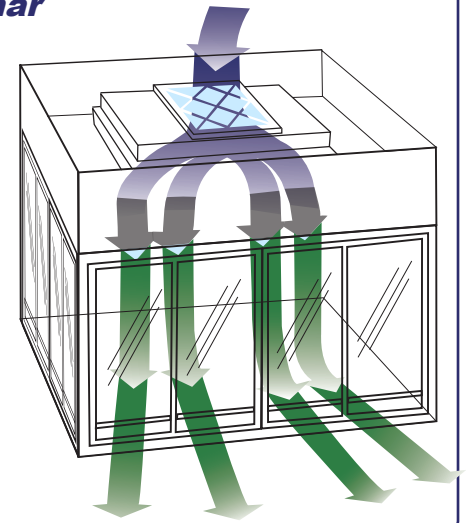

Unitized EnviroMax HEPA Filtered Clean Workstation. Sizes are 4', 5', 6', & 8' wide by 60" high



Project: Wyeth / Pfizer
EnviroMax laminar flow enclosure
size: 72" wide X 36" deep X 60" high with
UV light, & standard base table

Unitized design with depth of 30" and 36" to allow passage through doorways for easy on-site set-up. HEPA filters provide sterile clean airflow through work area with air returned to room space. Pre-wired electrical connection to a single point junction box. Work surfaces & support benches available.

Note: Custom sizes are welcomed.

Unitized Construction Sizes			
Width	Depth	Height	Cat. No.
48"	30"	60"	63041
60"	30"	60"	63051
72"	30"	60"	63061
96"	30"	60"	63081
48"	36"	60"	63042
60"	36"	60"	63052
72"	36"	60"	63062
96"	36"	60"	63082

Unitized EnviroMax Specifications Clean Workstation

Superstructure is welded steel framework with chemical resistant white powder coated finish. Side and rear walls are of clear acrylic or tempered glass. The front comes equipped with horizontal slide windows with air outlet slots on sides and front to maintain positive pressure. HEPA filters are ceiling mounted in the enclosure and designed to maintain a minimum of class 100 environment. HEPA filters are 99.99% efficient at .3 micron HEPA filter module has an integral fan, prefilter, and speed control. Fluorescent lighting is provided, switches are located on the front post. Provides an economical and flexible work space that exceeds stringent contamination requirements. All electrical components are U.L. listed.

Modular EnviroMax HEPA Filtered Clean Workstation. Sizes are 6', 8', 10' & 12' wide by 48" & 60" deep by 60" high



Project: Medtronics
Unitized EnviroMax 96" wide X 36" deep X 60" high, base table 96" wide X 36" deep X 36" high, with sliding sashes front and back and side hinged sashes

Modular design with depths of 48" & 60" for on-site assembly prior to setup and electrical connection. HEPA filters provide sterile clean airflow through work area and returned to room air space. Pre-wired electrical connection to single point junction box. Under the bench storage and shelving designed to suit your requirements.

Note: Custom sizes are welcomed.

Modular Construction Sizes			
Width	Depth	Height	Cat. No.
72"	48"	60"	64061
96"	48"	60"	64081
120"	48"	60"	64101
144"	48"	60"	64121
72"	60"	60"	64062
96"	60"	60"	64082
120"	60"	60"	64102
144"	60"	60"	64122

Modular EnviroMax Clean Workstation

Superstructure is welded steel framework with chemical resistant white powder coated finish. Side and rear walls are of clear acrylic or tempered glass. The front comes equipped with horizontal slide windows with air outlet slots on sides and front to maintain positive pressure. HEPA filters are ceiling mounted in the enclosure and designed to maintain a minimum of class 100 environment. HEPA filters are 99.99% efficient at .3 micron. HEPA filter module has an integral fan, prefilter, and speed control. Fluorescent lighting is provided. Switches are located on the front post. All electrical components are U.L. listed.

UNIMAX FLOOR MOUNTED (WALK-IN) FUME HOODS

UniMax Floor Mounted (Walk-in) Hoods are designed to safely isolate equipment, materials, and procedures from the surrounding area and exhaust hazardous fumes.



UniMax 16'w X 6'd X 12'h
LED lighting, FG framed glass door with
overhead sliding track, & center wall divider.
Cat No. 161072

UniMax FM Hoods Modular Construction

UniMax Floor Mounted Hoods are supplied in standard models from 6' to 24' wide, with various depth and height options. The unique modular construction features 2" thick walls that have chemical and fire resistant composite resin U.L. 1805 compliant surface panels, and meets ASTM E-84. This also allows the hood to ship knockdown and be moved through standard lab entry doors for easy on site assembly.

Engineered To Meet Your Project Requirement

Equipped with vapor proof fluorescent light, LED, or, explosion proof light fixtures that are available, in 115V 60Hz or 230V 50Hz electrical service. All factory installed.

UniMax Entry Access Door Options:

Add FG, FS, SC suffix to model number.

FG – Framed Glass Door with Overhead Sliding Track Supplied with (4) doors on (2) tracks, doors slide horizontally in an overhead track.

FS – Framed Glass Door with Floor Sliding Track Supplied with (4) doors on (2) tracks, doors slide horizontally in a lower floor track. The floor track threshold is 0.75" high.

SC – Strip Curtains Clear vinyl strip curtains provide containment in addition to the ability to move drums, cylinders, or equipment easily through for processing or storage.

UNIMAX FLOOR MOUNT (WALK-IN) HOOD DESCRIPTIONS

Select a UniMax hood size. A. select width, B. select height, C. select depth

UniMax Floor Mount Hood Enclosures are perfect for the cannabis industry to isolate, contain, and vent extraction equipment processes. These hoods are designed to meet the size requirements and accessibility needs.

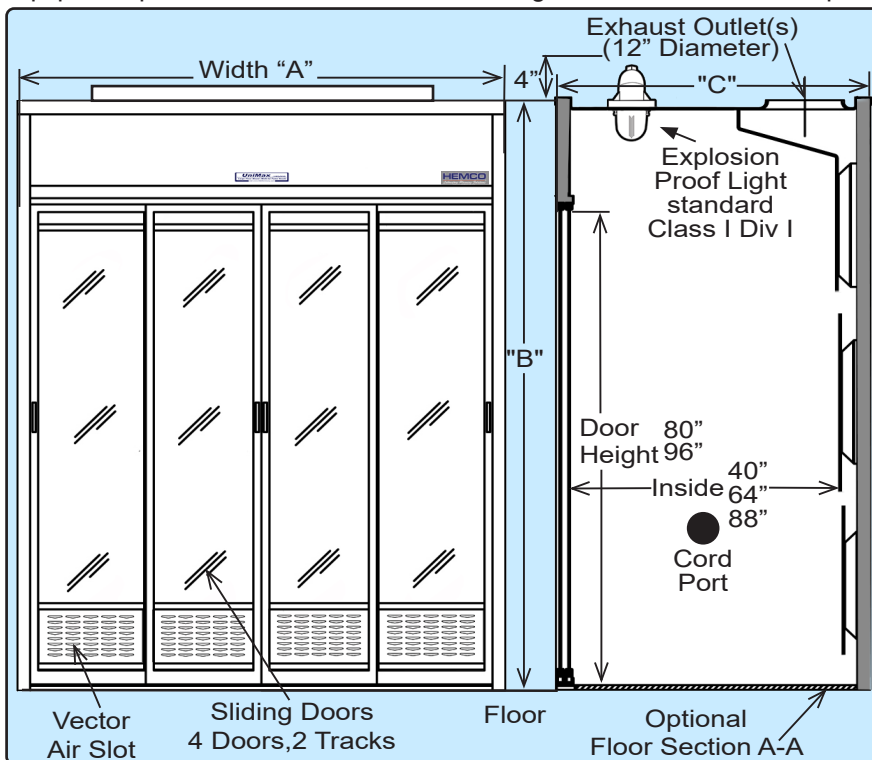

Dimensions		Depth "C"			Number of Exhaust Outlets
Width "A"	Height "B"	48" outside 42" inside	72" outside 66" inside	96" outside 90" inside	
6'	8'	60848	60872	60896	(1) 12" Dia
	10'	61048	61072	61096	
	12'	61248	61272	61296	
8'	8'	80848	80872	80896	(2) 12" Dia
	10'	81048	81072	81096	
	12'	81248	81272	81296	
10'	8'	100848	100872	100896	(2) 12" Dia
	10'	101048	101072	101096	
	12'	101248	101272	101296	
12'	8'	120848	120872	120896	(3) 12" Dia
	10'	121048	121072	121096	
	12'	121248	121272	121296	
16'	8'	160848	160872	160896	(4) 12" Dia
	10'	161048	161072	161096	
	12'	161248	161272	161296	
20'	8'	200848	200872	200896	(5) 12" Dia
	10'	201048	201072	201096	
	12'	201248	201272	201296	
24'	8'	240848	240872	240896	(6) 12" Dia
	10'	241048	241272	241296	
	12'	241248	240272	240296	

Fume Hood Fire Suppression System for UniMax

Recommended for potentially flammable or volatile applications. System is designed to meet various fire classifications and sized to fit the specific interior cubic dimensions of UniMax.

(consult factory for details)



UniMax FM Hoods Modular Construction

UniMax Floor Mounted Hoods are supplied in standard models from 6' to 24' wide, with various depth and height options. The unique modular construction features 2" thick walls that have chemical and fire resistant composite resin U.L. 1805 compliant surface panels, and meets ASTM E-84. This also allows the hood to ship knockdown and be moved through standard lab entry doors for easy on site assembly.

UniMax Explosion Proof Lighting Options

Explosion Proof Light Fixture UL listed. Class I Div II Groups A,B,C,D, Class II Div II Groups F & G. For use in hazardous locations. (bulb not included) 115V or 230V. not wired. **Cat. No. 50034**



Explosion-Proof Light Fixture UL listed. Class I Div I Group C,D, Class II Div I Group E, F,G. For use in hazardous locations. Accepts bulb up to 300 watts, (bulb not included) 115 / 230V. not wired. **Cat. No. 50038**



UniMax Entry Access Door Options:

Add FG, FS, SC suffix to model number.

FG – Framed Glass Door with Overhead Sliding Track

FS – Framed Glass Door with Floor Sliding Track

SC – Strip Curtains

HazMax Spill Containment Basins

HazMax spill Basins are designed to be used with UniMax Floor Mounted Hoods. Basins feature a molded one-piece seamless composite resin spill containment basin. The basin is 8" high and includes a raised fiberglass deck grating.



- Lower basin is of molded one-piece seamless chemical resistant composite resin construction to safely contain accidental spillage.
- Raised deck grating is of chemical resistant fiberglass material that allows spillage to flow through to basin below, self draining can be accommodated. Containment basin can be engineered to contain a specified volume of liquid.
- Engineered to meet the anticipated weight loads.
- Convenient lift out grating allows access to basin for cleaning and decontamination.
- Lower basin can be engineered to accommodate fork lift requirements.

Canopy Hoods

Canopy hoods are designed to collect and exhaust corrosive vapors, heat, steam, and odors when mounted over areas with water baths, hot plates, or portable equipment. Standard color: Lab White

Wall Canopy Hoods (FRP or stainless steel, Includes wall mounting kit) (custom sizes available)

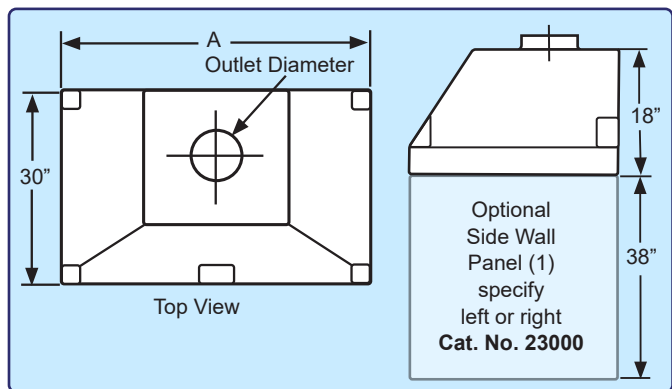

Side Wall Panel
(fiberglass or stainless steel)
kit includes one wall panel and hardware.
Cat. No. 23000

Rear Wall Panel
(consult chart for Cat.No.)

Vapor Proof Light & Switch Cat. No. 50035

Blower Switch 115V/15A
Cat. No. 50028

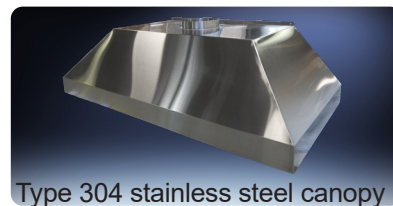

Type 304 stainless steel canopy



Fiberglass canopy hood with optional side walls

Width A	36"	48"	72"	96"	Side Wall Panels
Fiberglass Cat. No.	13030	13040	13060	13080	23000
Fiberglass Rear Wall Panel	23016	23026	23036	23046	--
Stainless Steel Cat No.	13130	13140	13160	13180	23011
Stainless Steel Rear Wall Panel	23116	23126	23136	23146	--
Diameter D	6"	8"	10"	(2) 10"	--

Island Canopy Hoods (FRP or stainless steel) (custom sizes available) (mounting kit not included)

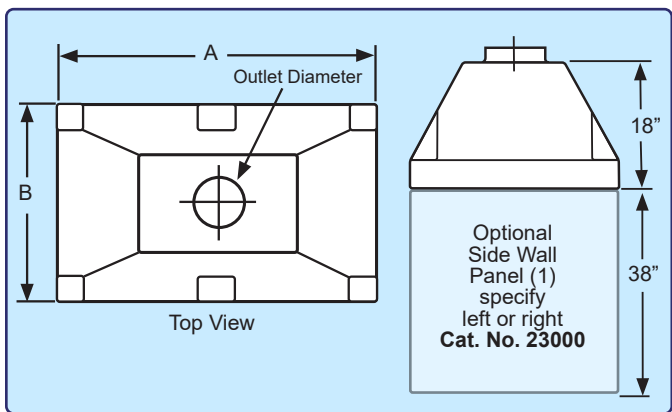

Suspended Island Canopy Hood Mounting Kit Includes all components to secure to ceiling including 6' long threaded rods.
Cat. No. 23001

Side Wall Panel
(fiberglass or stainless steel)
kit includes one wall panel and hardware. Cat. No. 23000

Rear Wall Panel
(consult chart for Cat.No.)

Vapor Proof Light & Switch Cat. No. 50035

Blower Switch 115V/15A
Cat. No. 50028



Type 304 stainless steel canopy hood with optional suspended mounting kit



Fiberglass canopy hood with optional suspended mounting kit

Width A	36"	48"	72"	96"	Side Wall Panels
Depth B	24"	30"	30"	30"	
Fiberglass Cat. No.	23030	23040	23060	23080	23000
Fiberglass Rear Wall Panel	23016	23026	23036	23046	---
Stainless Steel Cat No.	23130	23140	23160	23180	23011
Stainless Steel Rear Wall Panel	23116	23126	23136	23146	---
Diameter D	6"	8"	10"	(2) 10"	---

Corner Canopy Hoods (FRP, Includes wall mounting kit)

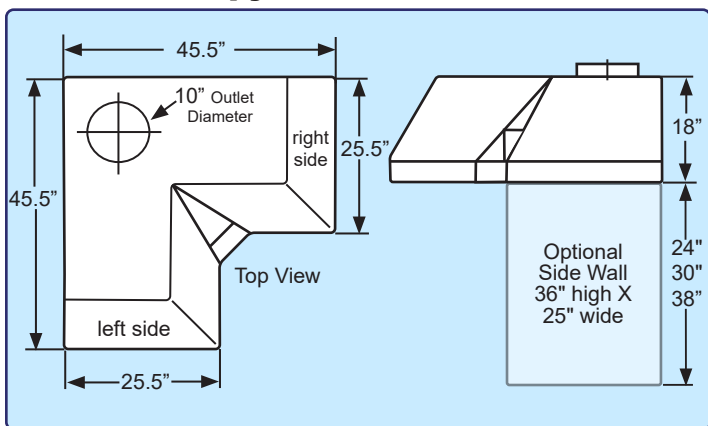

Side Wall Panels (fiberglass) 36" h X 25" w, kit includes one wall panel and hardware
Cat. No. 23006

Rear Wall Panels (2) required
Qty (1) 36" high X 45" wide
Cat. No. 23056

Vapor Proof Light & Switch Cat. No. 50035

Blower Switch 115V/15A
Cat. No. 50028

Corner Composite Resin Worksurface Gray, Comes dished to contain spillage.
Cat. No. 13503

Corner Table Features White welded steel construction. Cat. No. 13502

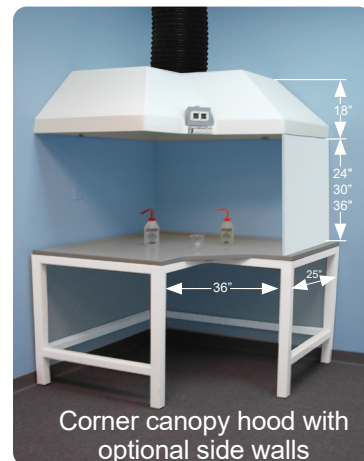

Corner canopy hood with optional side walls

Corner Canopy (includes mounting kit, to install canopy to two adjacent walls) Cat. No. 13000

Laboratory Emergency /Shower Decontamination Booths

Full body emergency shower & eye / face wash, both with immediate response activation handle.

Durable one-piece seamless fiberglass construction with glass smooth white surfaces and covered corners for ease of clean-up.

Emergency showers available with translucent frosted strip curtains, which provides for easy access into booth, while containing contaminated water splash.

Stainless steel Grab bars located on right & left sides to support victim and rescue personnel during decontamination, included.

Plumbing is provided, for installation by local certified plumber. Plumbed to single point 1.25" IPT. connection. Tempered warm water supply connection 20 GPM water supply is required.

Raised fiberglass deck with self draining containment basin, and 2" diameter drain outlet located on either the bottom or rear of unit.

Industrial Applications
Emergency Drench Shower Booth
 unit is equipped with pull rod activated overhead drench shower and rear wall mounted eye/face wash.
Cat No. 16601

Laboratory Applications
Emergency Drench Shower Booth
 same specs as above except with finished exterior side panels.
Cat No. 16604



Cat. No. 16601
 For Industrial Applications
 shown above

Note: OSHA & ANSI require that emergency shower is to be located within 10 seconds walking time from the hazardous site location.



Overhead Drench Shower

Shower unit features 10" diameter plastic head and 1" IPS brass "stay open" valve with rigid pull rod and handle. **Cat. No. 16088**



Alarm Horn & Light
 Audible warning sound when system is activated by flow switch. Top mounted visual warning light when system is activated.
Cat. No. 16680



Eye/Face Wash

Wall mounting unit features two large plastic heads, push plate operated "stay open" ball valve. 1/2" IPS inlet, and 1.25" IPS drain. **Cat. No. 16006**

Eye and Face Wash Options



Hand Held Body Wash
 Squeeze valve nozzle on 8' coiled hose and bracket. Can be used to rinse all body parts while victim is sitting or lying down. Wall or hood mounted, 3/8 NPT, barrier free.
Cat No. 16005



Swing-Out Eye Wash
 Deck mounted next to sink. Activates when pivoted. 1/2" NPT. Barrier free.
Cat. No. 16009



Hand Held Eye/Face & Body Wash
 Mounted on the front side-wall of the fume hood. Includes 8' hose and surface escutcheon. 3/8" NPT. barrier free.
Cat. No. 93966

**Most Extensive Line of Laboratory Fume Hoods in the Industry
Reduce Energy costs up to 50% with HEMCO Sash Management 1-2-3,
which provides maximum energy efficiency and user protection.**



UniFlow

Laboratory Fume Hoods are available in

1. Constant Air Volume CAV Air Bypass
2. Variable Air Volume VAV Restricted Bypass
3. Explosion Proof models for Hazardous Locations
4. CE models for International Electronic Configurations



Standard Bench Mount and Floor Mount hoods with over 40 standard sizes and custom sizes to your specs. UniFlow Superstructure exclusive unitized dual wall construction for total chemical resistance, strength, and durability. Performance tested to ASHRAE 110 - 1995. U.L.1805 Classified for Fume Hoods & Cabinets, and SEFA1 Recommended Practices for Fume Hoods.

Request a free brochure At www.HEMCOcorp.com and browse the entire selection of HEMCO Laboratory Equipment



Lab Planning Solutions
Complete Laboratory
Planning Guide



UniMax Large
Floor Mount Walk-In
Fume Hoods Brochure



EnviroMax Enclosures for
Robotic and Automated
Lab Processes



Modular Clean Labs
& Quality Control Labs
Brochure



Laboratory
Ventilation
Brochure



Find our products with **ARCAT.com**

**Specify UniFlow Fume Hoods
on Your Next Lab Project**

Address

654 Petrolia Road,
Toronto, ON M3J 2W3

Tel: (416) 736-6166

Toll Free: (800) 387 3570

Fax: (416) 736-9346

E-mail: info@betatekinc.com

